

isNet Line

Modular Gateway Solution

MANUAL



CERTIFICATE OF CONFORMITY EU

According to EC Directive 2014/30/EU (electromagnetic compatibility) of February 26th 2014 and according to EC Directive 2011/65/EU (RoHS II) of June 8th 2011. We hereby declare, that the devices indicated below in its design and construction, are in conformity

with the essential safety and health requirements of the EC Directive 2014/30/EU. The devices do not contain material as declared in the EC Directive 2011/65/EU (RoHS II).



CHANGES OR MODIFICATIONS NOT APPROVED BY THORSIS TECHNOLOGIES VOID THE VALIDITY OF THE DECLARATION.

Product name	Order code
isNet Lite	19300-0101
isNet DP	19300-0401
isNet DP2	19300-0501
isNet DiagM PA	19300-1201
isNet H@rt 4	19300-0601
isNet H@rt 8	19300-0701
isNet H@rt8+AI	19300-0702
isNet DIO4	19300-1301
isNet FF	19300-1701
isNet FF2	19300-1801
isNet FF4	19300-1901
isNet DIO8	19300-1401
isNet DPMon	19300-0201
isNet PAMon	19300-0301
isNet FFMon	19300-0801

STANDARDS USED: EN 61326-1:2013

Manufacturer

Thorsis Technologies GmbH
Oststr. 18
39114 Magdeburg
Germany

Magdeburg, January 31, 2023

Dipl.-Inf. Michael Huschke,
General Manager

UK DECLARATION OF CONFORMITY

Thorsis Technologies GmbH declares as manufacturer under sole responsibility, that the products down in the list complies with the requirements of following UK legislation:

- S.I. 2019/1246 The Product Safety, Metrology and Mutual Recognition Agreement (Amendment)(EU Exit) regulations 2019
- S.I. 2020/852 The Product Safety and Metrology (Amendment)(EU Exit) regulations 2020
- S.I. 2016/1091 The Electromagnetic Compatibility Regulations 2016
- S.I. 2012/3032 The Restriction of the Use of Certain Hazardous Substances in Electrical and Electronic Equipment Regulations 2012



**CHANGES OR MODIFICATIONS NOT APPROVED
BY THORSIS TECHNOLOGIES VOID THE VALIDITY
OF THE DECLARATION.**

STANDARDS USED: EN 61326-1:2013
CERTIFICATION: NONE

Product name	Order code
isNet Lite	19300-0101
isNet DP	19300-0401
isNet DP2	19300-0501
isNet DiagM PA	19300-1201
isNet H@rt 4	19300-0601
isNet H@rt 8	19300-0701
isNet H@rt8+AI	19300-0702
isNet DIO4	19300-1301
isNet FF	19300-1701
isNet FF2	19300-1801
isNet FF4	19300-1901
isNet DIO8	19300-1401
isNet DPMon	19300-0201
isNet PAMon	19300-0301
isNet FFMon	19300-0801

Manufacturer

Thorsis Technologies GmbH
Oststr. 18
39114 Magdeburg
Germany

Magdeburg, January 31, 2023

Dipl.-Inf. Michael Huschke,
General Manager



Table of Content

1.	ISNET LINE	6	1.7	isNet FF	27
1.1	Dimensional drawing	8	1.7.1	Technical details	28
1.2	isNet Lite	9	1.7.2	Channel assignment.	29
1.2.1	Channel assignment	10	1.7.3	Hardware Installation	30
1.2.2	Hardware Reset isNetLite	11	1.8	isNet DIO	31
1.2.3	Technical details	12	1.8.1	Technical details	32
1.3	isNet DP	13	1.8.2	Channel assignment.	33
1.3.1	Technical details.	14	1.9	isNet PAMon and DPMon.	34
1.3.2	Channel assignment.	15	1.9.1	Technical details	35
1.4	isNet DiagM PA	16	1.9.2	Channel assignment.	36
1.4.1	Technical details.	17	1.10	isNet FFMon	37
1.4.2	Channel assignment.	18	1.10.1	Technical details	38
1.4.3	Connection with a PLC.	18	1.10.2	Channel assignment.	39
1.4.4	Hardware Installation	19	2.	HARDWARE INSTALLATION	40
1.5	isNet H@rt	20	2.1	Safety instructions	40
1.5.1	Technical details.	21	2.2	Mechanical installation	41
1.5.2	Channel assignment.	22	2.2.1	Specific conditions of use	42
1.5.3	Connection to a slave.	22	2.3	Electrical installation	43
1.5.4	Connection with a PLC.	23	3.	WEB INTERFACE	44
1.6	isNet H@rt+AI	24	3.1	Configuration of the IP address	45
1.6.1	Technical details.	25	3.2	Update of the Firmware	46
1.6.2	Channel assignment.	26	3.3	Soft-Restart.	46
1.6.3	Connection to a slave.	26	3.4	Password Protection.	47

Table of Content

3.5	Activating MODBUS functionality	48
3.6	MODBUS status.	49
3.7	HART over IP	50
4.	FDT CONFIGURATION	51
5.	ISNET LITE – PROFINET	55
5.1	Workflow of the engineering process	56
5.2	Creation of the GSDML file	57
5.2.1	Step 1: Configuration of modules.	58
5.2.2	Step 2: Configuration of PROFIBUS slaves	60
5.2.3	Step 3: Export of the GSDML file	61
5.3	Integration in SIMATIC Manager.	62
5.3.1	Import of the GSML file.	62
5.3.2	Setting up properties for isNet PNGate	65
5.3.3	Setting up PROFIBUS	67
5.3.4	Adding fieldbus slaves to the engineering project	68
5.3.5	Parameterisation of PROFIBUS slaves and modules.	70
6.	ISNET LITE – MODBUS.	71
7.	ISFIELDDIAGNOSIS.	72
8.	DECLARATION OF ROHS CONFORMITY	73
9.	DOCUMENT HISTORY	74

1. isNet Line

The product family isNet Line is a modular gateway solution to integrate legacy fieldbuses like HART, Profibus or FOUNDATION Fieldbus into Ethernet based fieldbus environments. It can be used as a gateway to connect e.g. HART Transmitters or Profibus slave devices to an Ethernet cable. Typical applications are for example device parameterization, asset management, fieldbus diagnosis, Profinet to Profibus gateways, Modbus/TCP to HART gateways or any other conceivable combination between Ethernet protocols and HART or Profibus protocols.

The system is modular and consists of an Ethernet head module and different fieldbus expansion modules. Expansion modules are available for HART, Profibus DP, Profibus PA as well as FOUNDATION Fieldbus. Up to 5 expansion modules can be mounted to a head module. Depending on the application a free combination of any of these expansion modules is possible.



overview



isNet Lite

PROFIBUS DP

isNet DP



isNet DP2



isNet DPMon



PROFIBUS PA

isNet DiagM PA



isNet PAMon



Foundation Fieldbus

isNet FF



isNet FF2



isNet FF4



isNet FFMon



HART

isNet H@rt Ex



isNet H@rt4



isNet H@rt8



isNet H@rt+AI



1.1 Dimensional drawing

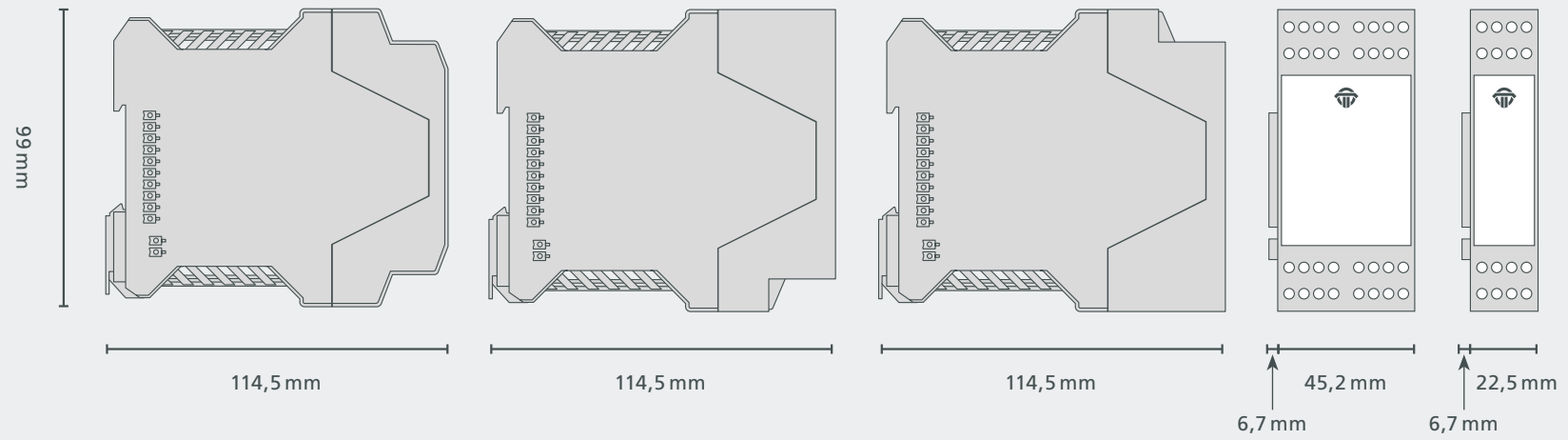

1.2 isNet Lite

The Ethernet module isNet Lite is the head module of every isNet Line gateway solution. In combination with any of the fieldbus expansion modules its purpose is to exchange process data between field devices and Ethernet based PLCs. Additionally it allows engineering stations to access field device parameters for configuration purposes, diagnosis and asset management.

The isNet Lite is equipped with a RJ45 socket for an Ethernet cable, a side connector for the fieldbus expansion modules and a 24V DC connector for power supply. Incoming power is also forwarded to the side connector to supply all connected fieldbus expansion modules.

The firmware of the isNet Lite implements Ethernet based fieldbus protocols for a direct communication link to a PLC. The gateway can be used as a Profinet device or as a Modbus-TCP server. For access to HART field devices the HART over IP protocol is implemented too. To provide parameter access from a PC based solution, a Communication DTM is available, which allows to integrate the isNet gateway into any FDT based application such as PACTware, Fieldcare or Asset Vision Basic. Also an OPC server is available for data access from any OPC client application. For further customization of the device, a driver interface allows integration into customer specific applications.

The isNet Lite can be controlled and configured by using a web interface which allows diagnosis and maintenance of the main module and its connected expansion modules (see chapter 3 “Web Interface” on page 43)



1.2.1 Channel assignment

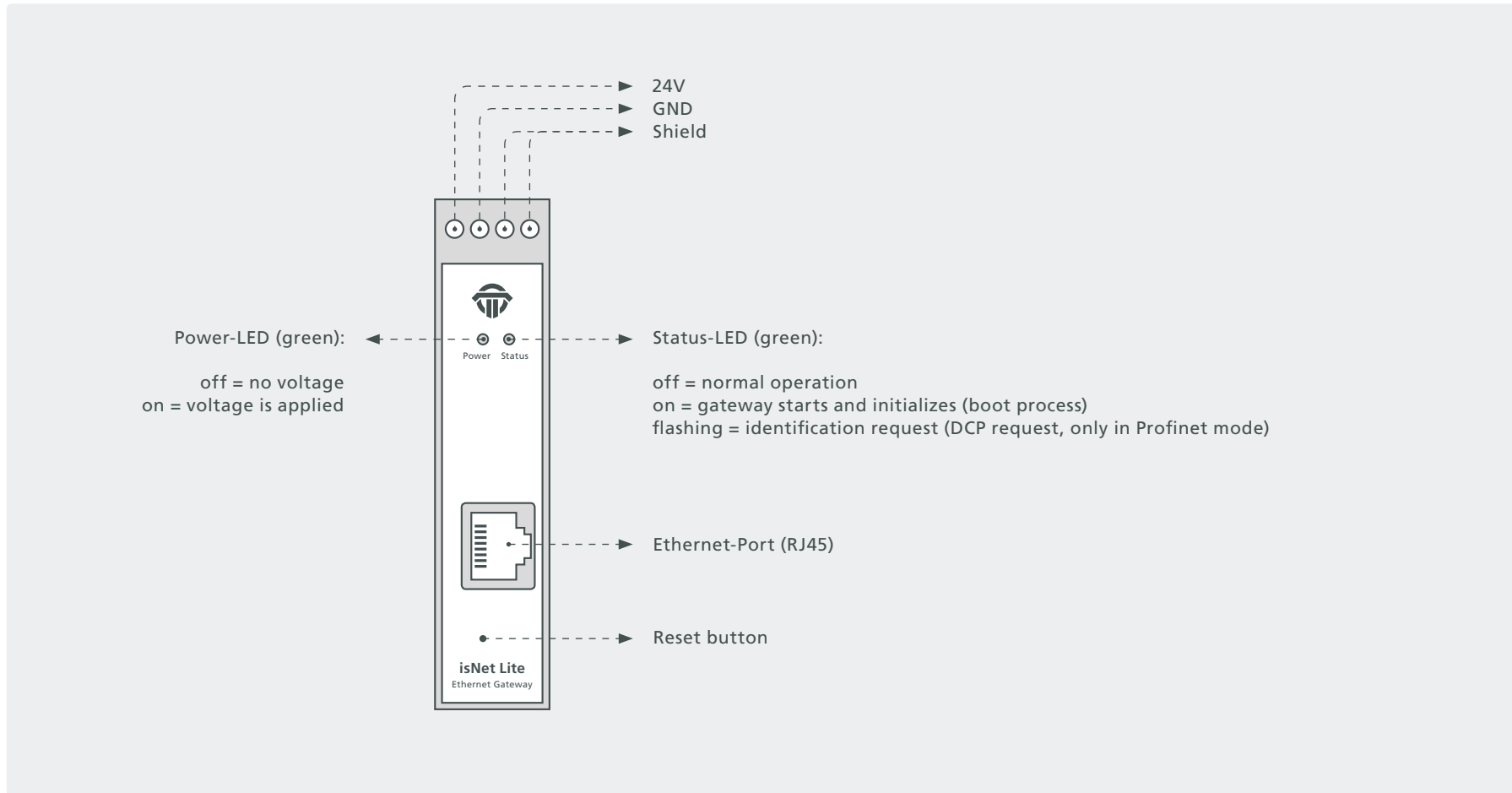

1.2.2 Hardware Reset isNet Lite



There may be reasons to restore firmware defaults of the isNet Lite like a failed firmware upgrade, a forgotten IP address or an IP address set to DHCP without having a DHCP server available in the network. In all these cases the user can reset the hardware back to firmware defaults by using the reset button. This button is located behind a small hole next to the RJ45 connector. In order to perform the firmware reset, the user needs to:

- switch off power from the hardware
- press the button (e.g. with a paper clip) and hold
- apply power again while still holding the reset button and
- wait for at least 5 more seconds before releasing the reset button

After releasing the reset button, the firmware will take some time to reinitialize to default settings, do not disconnect from power. As a result of a firmware reset, the module will have its default IP address 192.168.0.10 and all firmware updates are undone.

1.2.3 Technical details

Electrical data

Interface	RJ 45 (Ethernet)
Controller	ARM9 32Bit 400 MHz
RAM	32 MB
Flash	256 MB
Transmission rate	Ethernet/PROFINET/MODBUS 10 Mbit/s ... 100 Mbit/s
Power supply	19,2 ... 30V DC, max 4A
Power consumption	1,1 W (typ.) ... 1,5W (max)
Max. buffer time RTC	2h

Mechanical data

LxWxH in mm	114,5 x 22,5 ⁽¹⁾ x 99
Weight	140 g
Wire size	0,5 mm ² ... 2,5 mm ² / AWG 20 ... AWG 12 ⁽⁴⁾

⁽¹⁾ Dimensions without lateral plugs

⁽⁴⁾ Cable entries and field wiring must be suitable for an operating temperature of at least +20°C above ambient.

Environmental data

Temperature range	- 40° C <= T _{amb} <= 70° C - 40° F <= T _{amb} <= 158° F
Storage temperature	- 40° C <= T _{amb} <= 85° C - 40° F <= T _{amb} <= 185° F
Pollution degree	2
Altitude	up to 2000 m

Content

Driver software	Windows XP, Vista, 7, 8, 10 and 11
Delivery content	Hardware, User manual isNet Line on CD
Order code	19300-0101

The default address of the module is: 192.168.0.10 subnet mask 255.255.255.0

1.3 isNet DP

With the isNet DP module the main module isNet Lite can be extended to work as a PROFIBUS-DP Ethernet Gateway. The main module can be enhanced with a maximum of 5 PROFIBUS modules. The isNet DP modules are available as one and two channel version, so up to ten PROFIBUS channels can be connected to a head station. The protocols DP and DP/V1 are supported. Access to the PROFIBUS network

is provided by a SubD9 connector (female). The modules offer all recognized baud rates of up to 12 Mbit/s.

The modules are operated via the isNet DP DTM from Thorsis Technologies. The DTM is compliant to the FDT 1.2.1 specification and integrates the gateway into every FDT-frame application.

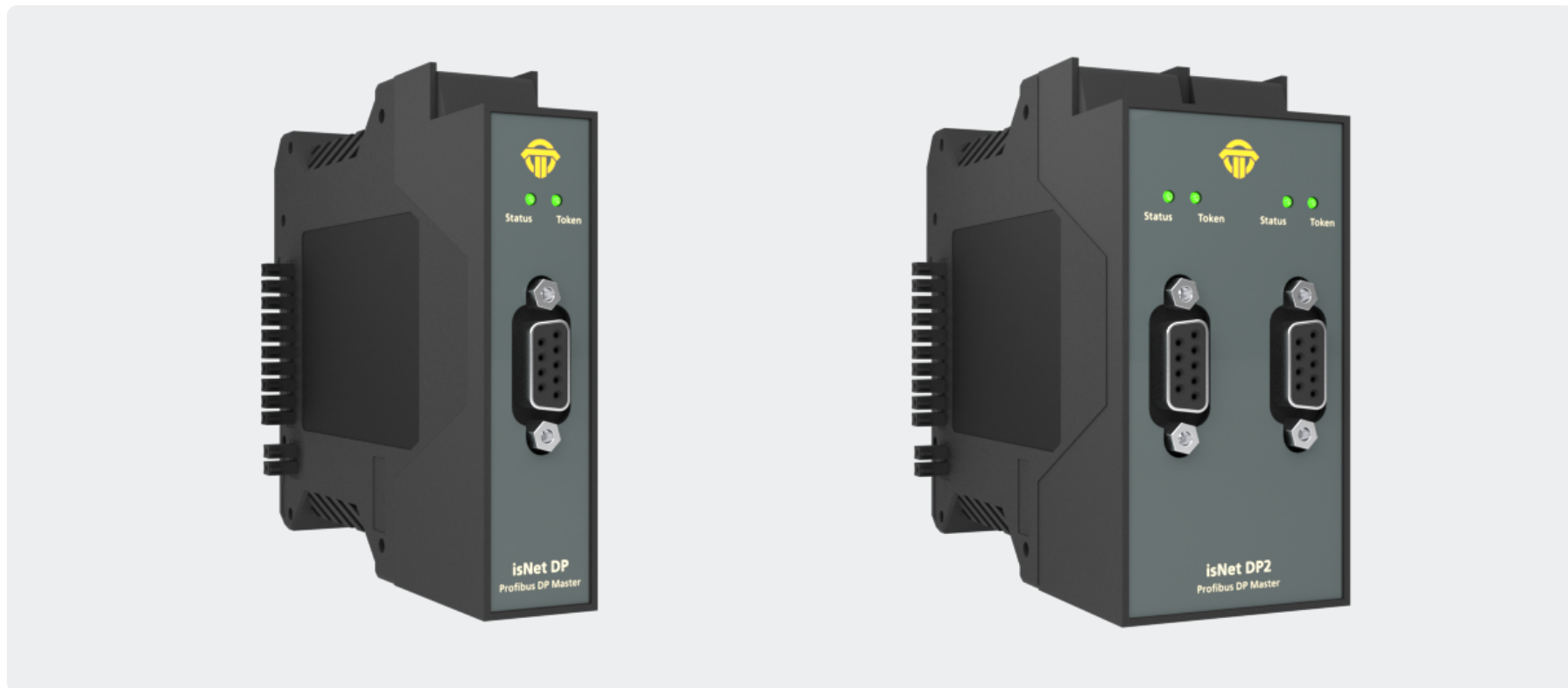

1.3.1 Technical details

	1-Channel isNet DP	2-Channel isNet DP2
Connectors	1 RS-485	2 RS-485
Power consumption	2,4W	2,5W
LxWxH in mm	114,5 x 22,5 ⁽¹⁾ x 99	114,5 x 45 ⁽¹⁾ x 99
Weight	140 g	250 g
Temperature range	0° C <= T _{amb} <= 50° C / 32° F <= T _{amb} <= 122° F	
Transmission rate	9,6 kbit/s ... 12,0 Mbit/s	
Driver software	Windows XP, Vista, 7, 8, 10 and 11	
Delivery content	Hardware, isNet DTM Library, Pactware, User manual isNet Line on CD	
Order code	19300-0401	19300-0501

⁽¹⁾ Dimensions without lateral plugs

1.3.2 Channel assignment

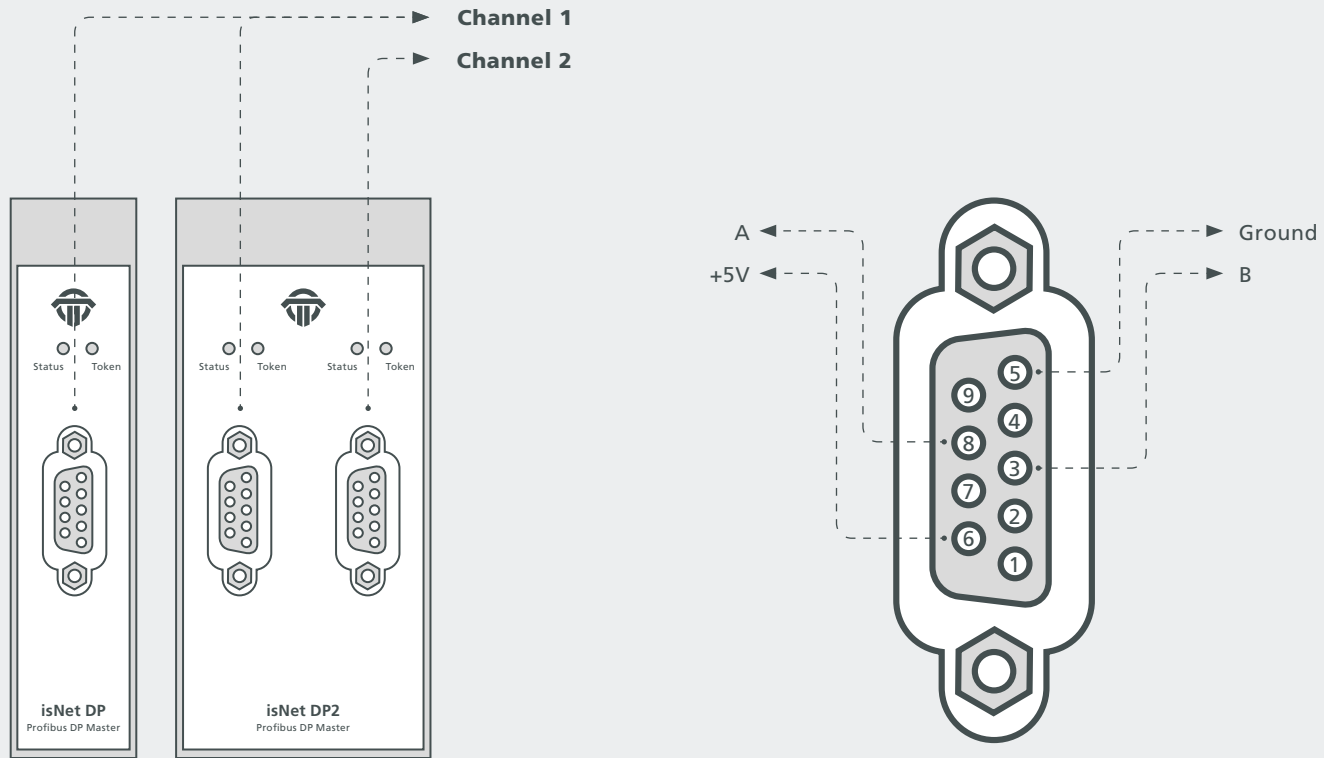

1.4 isNet DiagM PA

The isNet DiagM PA module is a Profibus Master with a PA physical layer interface. It allows direct connection of Profibus PA field devices without the need of a DP/PA converter. The module can serve as a fieldbus power supply for the PA slaves or it can also be connected to an existing and already powered PA segment as an additional master.

In combination with the isNet Lite the module can be used as a gateway between Profinet and Profibus PA or as a Modbus-TCP to Profibus PA converter. In parallel to process data exchange the gateway allows access to the parameters of the PA slave devices via FDT or OPC. Furthermore, the module contains some diagnostic functionality like a protocol monitor that can run simultaneously to the master to record data traffic for failure analysis, data logging or other purposes.



1.4.1 Technical details

1-Channel isNet DiagM PA	
Connectors	1 screw terminals
Power consumption ⁽²⁾	2,0W
LxWxH in mm	114,5 x 45 ⁽¹⁾ x 99
Weight	250 g
Temperature range	- 40° C <= T _{amb} <= 60° C / -40° F <= T _{amb} <= 140° F
Storage temperature	- 40° C <= T _{amb} <= 85° C / - 40° F <= T _{amb} <= 185° F
Transmission rate	31,25 kbit/s
Driver software	Windows XP, Vista, 7, 8, 10 and 11
Delivery content	Hardware, isNet DTM Library, Pactware, User manual isNet Line on CD
PA supply/channel	300 mA
PA supply voltage	22 ... 24V
Order code	19300-1201

⁽¹⁾ Dimensions without lateral plugs

⁽²⁾ without fieldbus slaves

1.4.2 Channel assignment

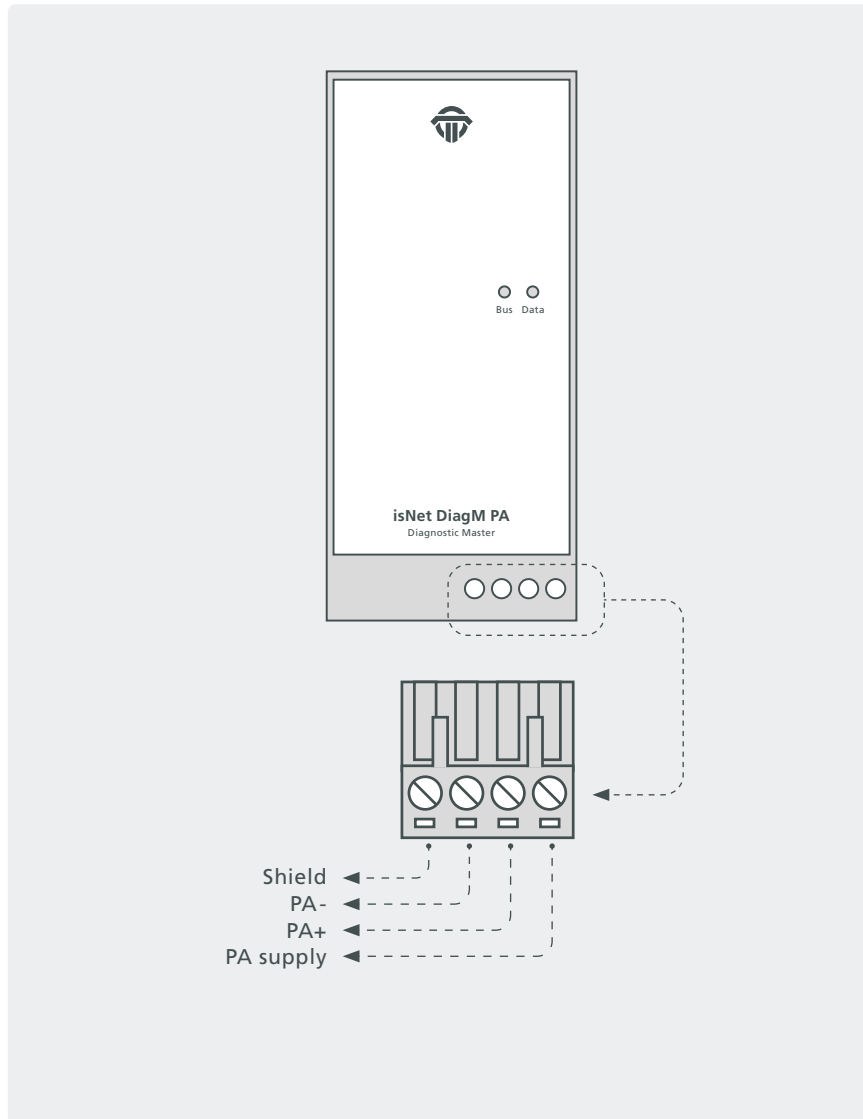

1.4.3 Connection with a PLC

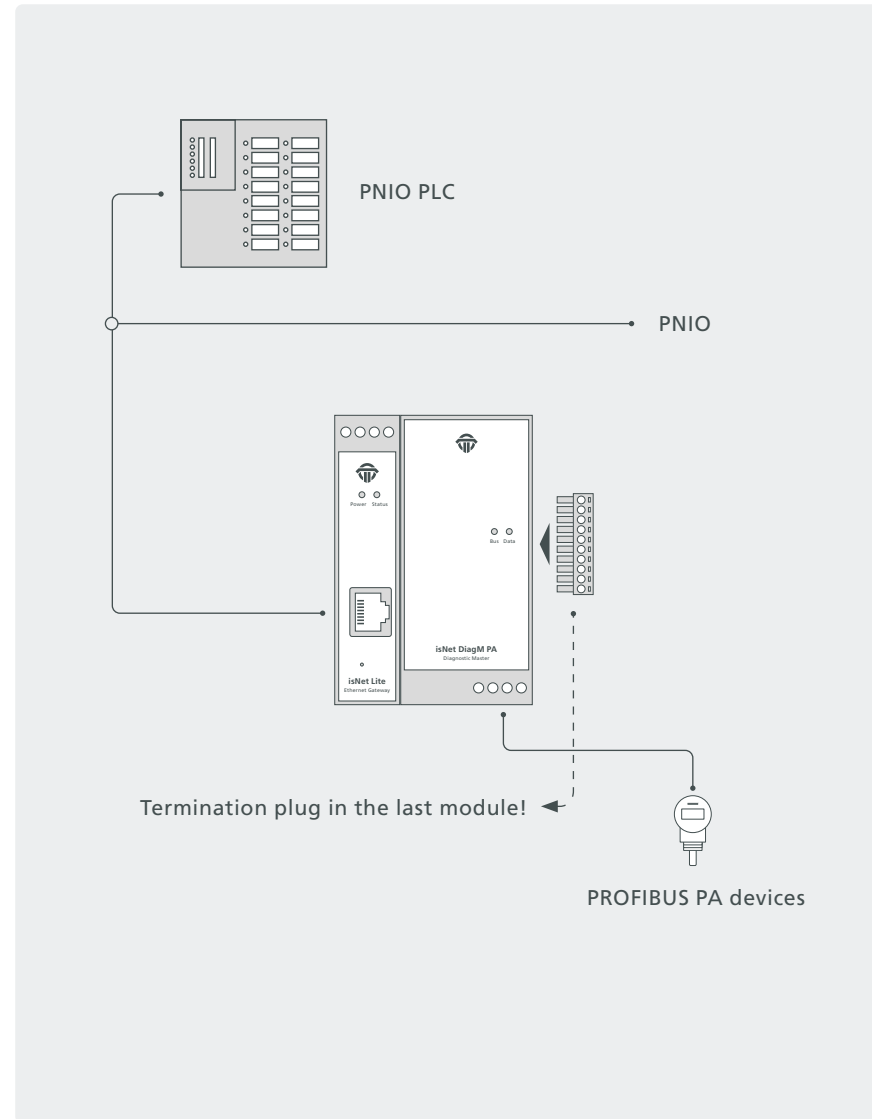

1.4.4 Hardware Installation

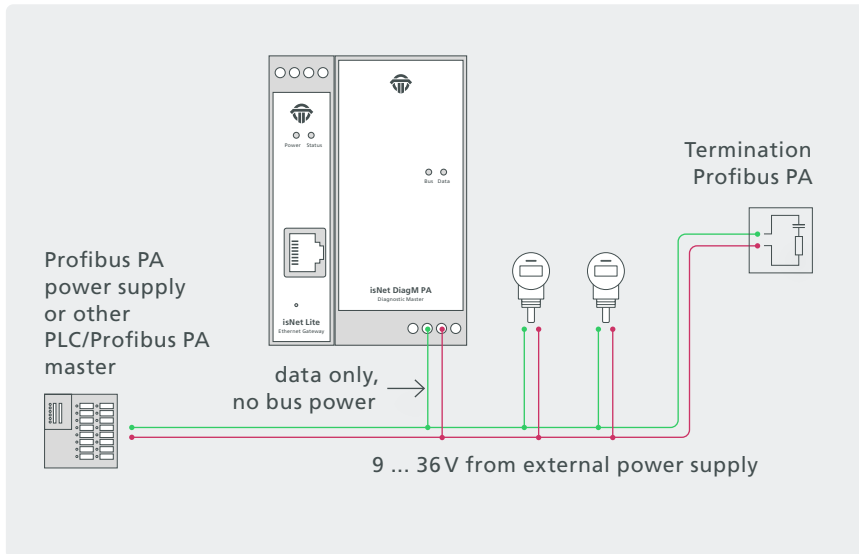

Connection with an external power supply

The PA modules enable you to connect to an existing PA network via the signal lines PA+ and PA-.

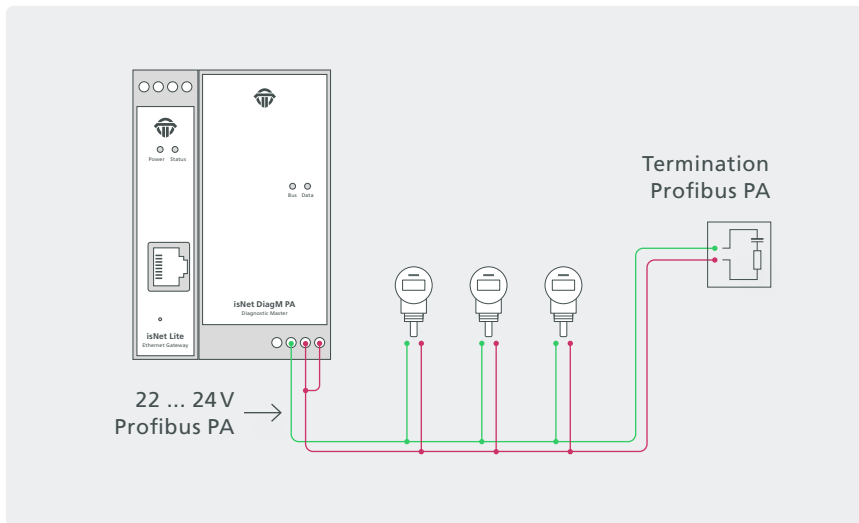

Connection without an external power supply

The PA fieldbus devices can be powered by the PA modules.

1.5 isNet H@rt

With the isNet H@rt Module the main module isNet Lite can be extended to work as an HART-Ethernet-Gateway. The HART-Ethernet-Gateway is an up-to-date option to replace the widely used RS485 HART multiplexer solutions, as it enables the direct connection to the existing data network of a plant. The isNet H@rt modules are equipped with either four or eight channels. Up to five HART modules can be connected to the main module, so a maximum of 40 HART channels can be operated in parallel. Each channel provides galvanic decoupling from the HART line. Access to the HART network is achieved by screw-type terminals.

Wiring from the isNet H@rt module to an existing control loop is as easy as connecting a mobile HART modem to the 2 HART wires. The

isNet H@rt module can be thought of as 4 (or 8) independent HART modems in a single enclosure. Each HART channel must be connected in parallel to the 2 wires of the control loop regardless of its polarity. Depending on the input impedance of the Analog Input line of the PLC a 240 Ohm communication resistor might be necessary. This applies especially to Analog Inputs without HART capability, which usually contain a small sense resistor with an input impedance of about 10 Ohm. If the PLC is HART enabled, the 240 Ohm resistor was already built in.

With the isNet H@rt CommDTM, the modules can be integrated in your FDT Frame Application. Based on the HART over IP protocol, access from the popular HCF OPC server is possible as well.

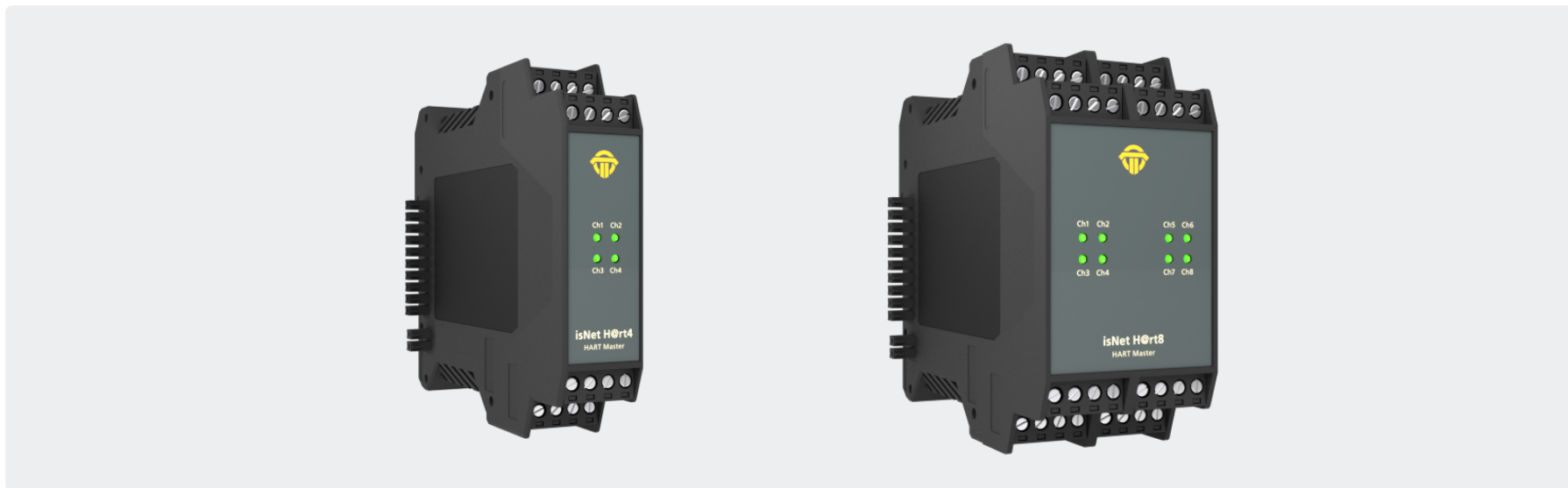

1.5.1 Technical details

	4 - Channel isNet H@rt4	8 - Channel isNet H@rt8
Connectors	4 screw type terminals	8 screw type terminals
LxWxH in mm	114,5 x 22,5 ⁽¹⁾ x 99	114,5 x 45 ⁽¹⁾ x 99
Power consumption	1,2W	1,4W
Weight	140 g	250 g
Temperature range	- 40° C ≤ T _{amb} ≤ 70° C / - 40° F ≤ T _{amb} ≤ 158° F	
Storage temperature	- 40° C ≤ T _{amb} ≤ 85° C / - 40° F ≤ T _{amb} ≤ 185° F	
Transmission rate	1200 Bit/s	
Pollution degree	2	
Altitude	up to 2000 m	
Wire size	0,2 mm ² ... 2,5 mm ² /AWG24 ... AWG 12 ⁽⁴⁾	
Driver software	Windows XP, Vista, 7, 8, 10 and 11	
Delivery content	Hardware, isNet DTM Library, Pactware, User manual isNet Line on CD	
Order code	19300-0601	19300-0701

⁽¹⁾ Dimensions without lateral plugs

⁽⁴⁾ Cable entries and field wiring must be suitable for an operating temperature of at least +20°C above ambient.

1.5.2 Channel assignment

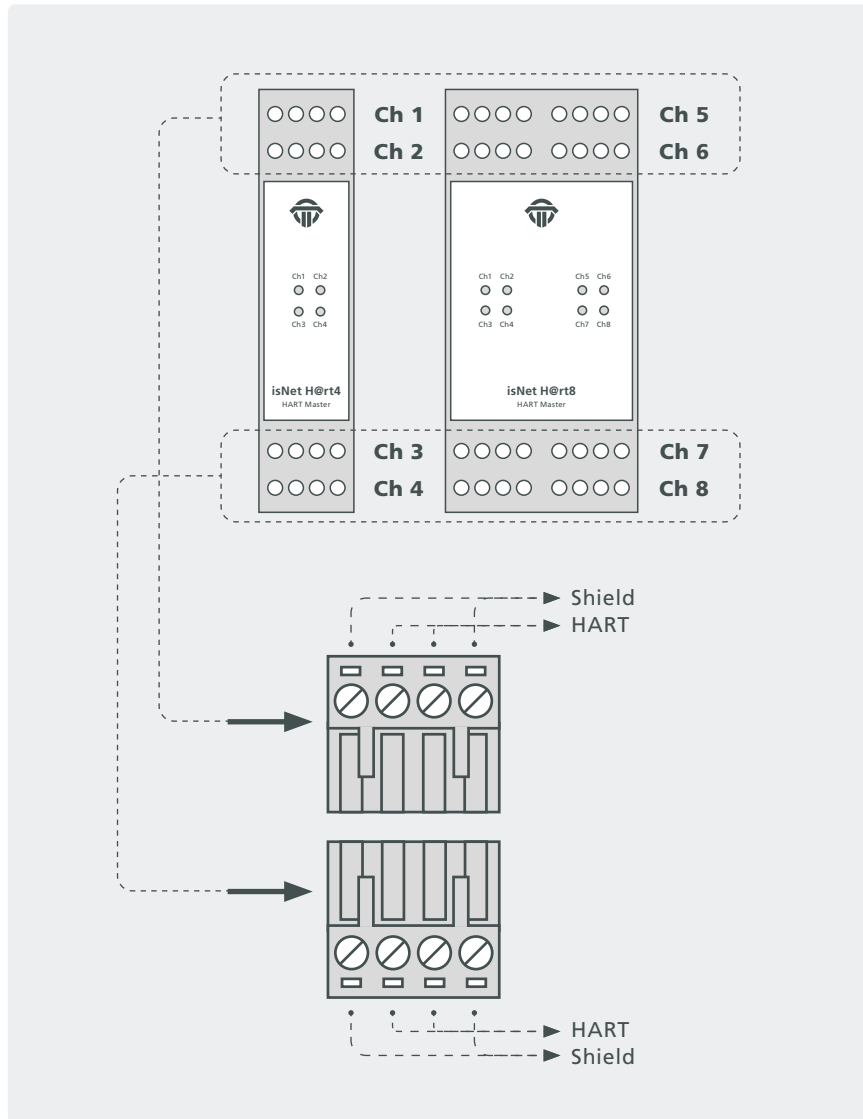

1.5.3 Connection to a slave

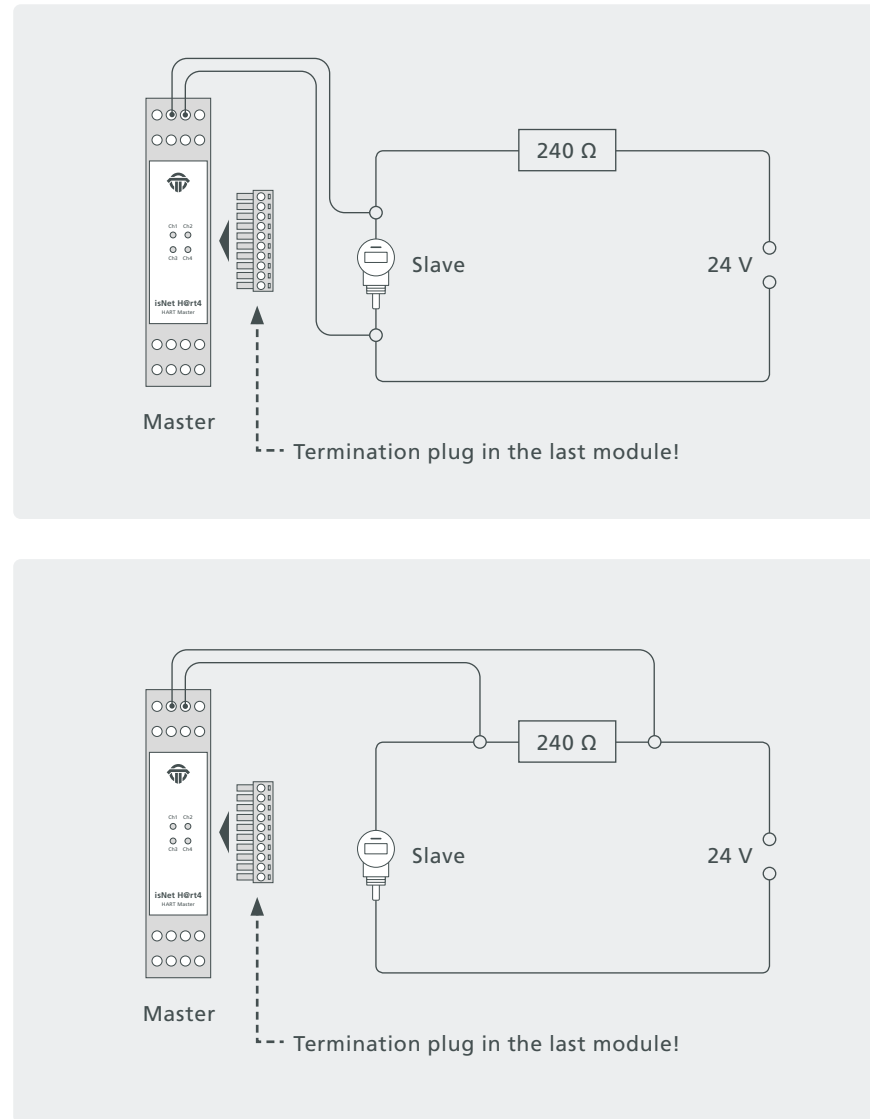

1.5.4 Connection with a PLC

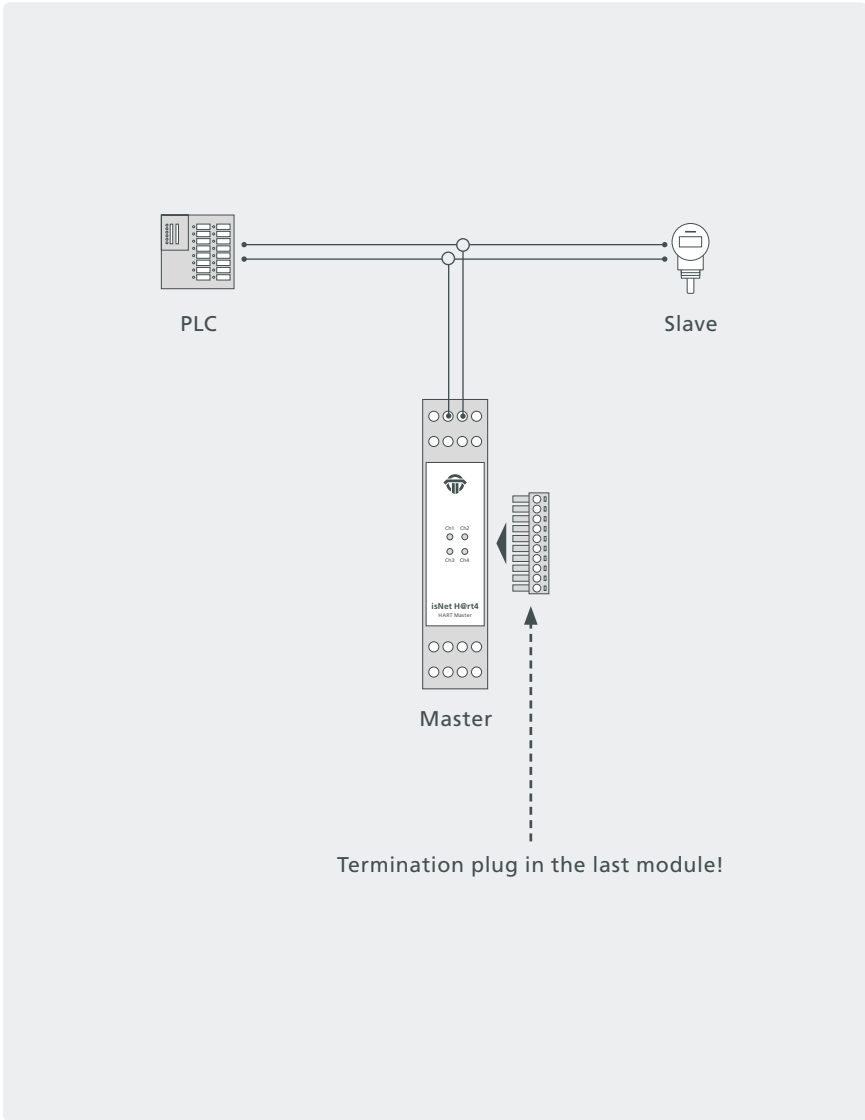

1.6 isNet H@rt+AI

The isNet H@rt8+AI module combines the HART master module with 4 ... 20mA Analog Input functionality. The module provides 8 active AI channels, which means the module will supply 24V DC to the HART loops and thus power the connected HART instruments. The HART instruments can be connected directly to the module, an external loop resistor is not required as the input impedance of the AI channels already is 240 Ohms.

The measured analog values can be read by a connected PLC using Modbus/TCP or Profinet. Due to the HART master functionality the PLC has also access to the digital values of the HART instruments. Additionally an engineering station can simultaneously access the HART parameters of the connected HART instruments for configuration, diagnosis or maintenance. This is possible with FDT based applications like PACTware, with OPC or with any other HART-IP client applications.



1.6.1 Technical details

8-Channel isNet H@rt8+AI	
Connectors	8 screw type terminals
LxWxH in mm	114,5 x 45 ⁽¹⁾ x 99
Power consumption	1,8W ⁽²⁾
Weight	250 g
Temperature range	- 40° C <= T _{amb} <= 70° C / - 40° F <= T _{amb} <= 158° F
Storage temperature	- 40° C <= T _{amb} <= 85° C / - 40° F <= T _{amb} <= 185° F
Pollution degree	2
Altitude	up to 2000 m
Wire size	0,2 mm ² ... 2,5 mm ² /AWG24 ... AWG 12 ⁽⁴⁾
Transmission rate (HART)	1200 Bit/s
Transmitter supply voltage	24V
max. current	25 mA (per channel)
Input impedance	250 Ω
Driver software	Windows XP, Vista, 7, 8, 10 and 11
Delivery content	Hardware, isNet DTM Library, Pactware, User manual isNet Line on CD
Order code	19300-0702

⁽¹⁾ Dimensions without lateral plugs

⁽²⁾ without fieldbus slaves

⁽⁴⁾ Cable entries and field wiring must be suitable for an operating temperature of at least +20°C above ambient.

1.6.2 Channel assignment

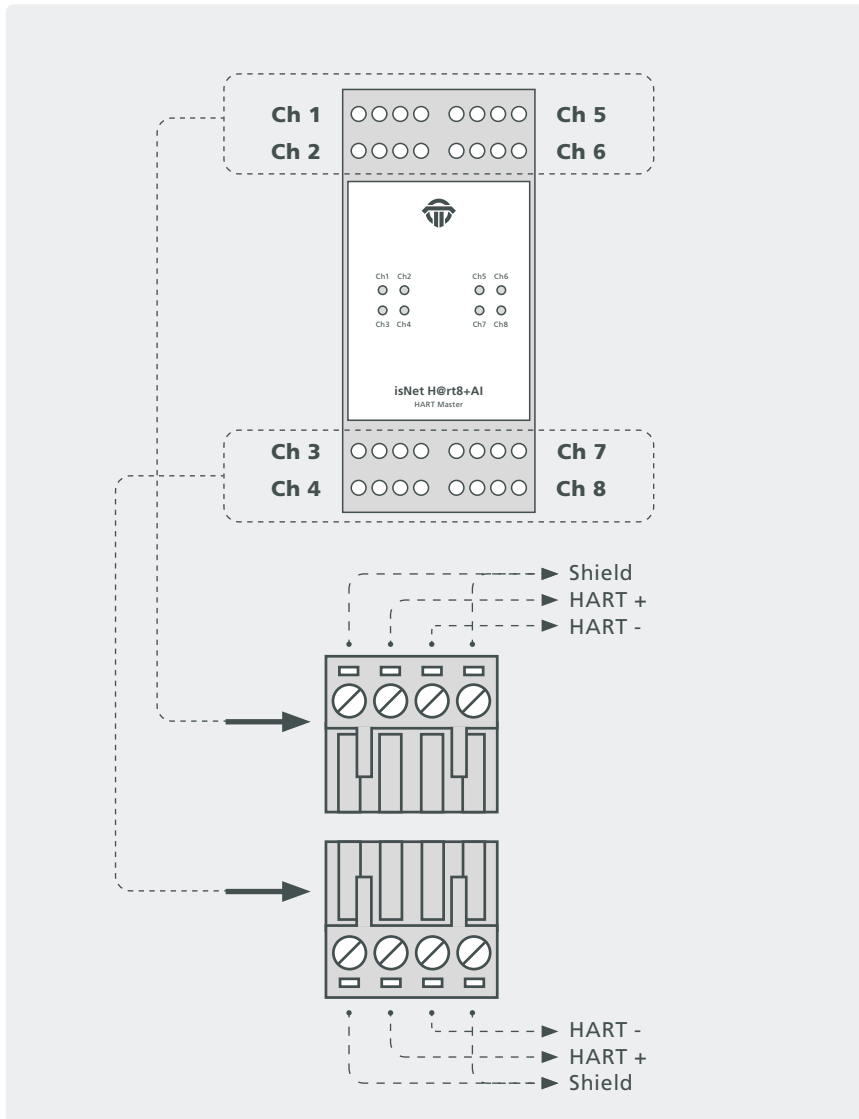

1.6.3 Connection to a slave

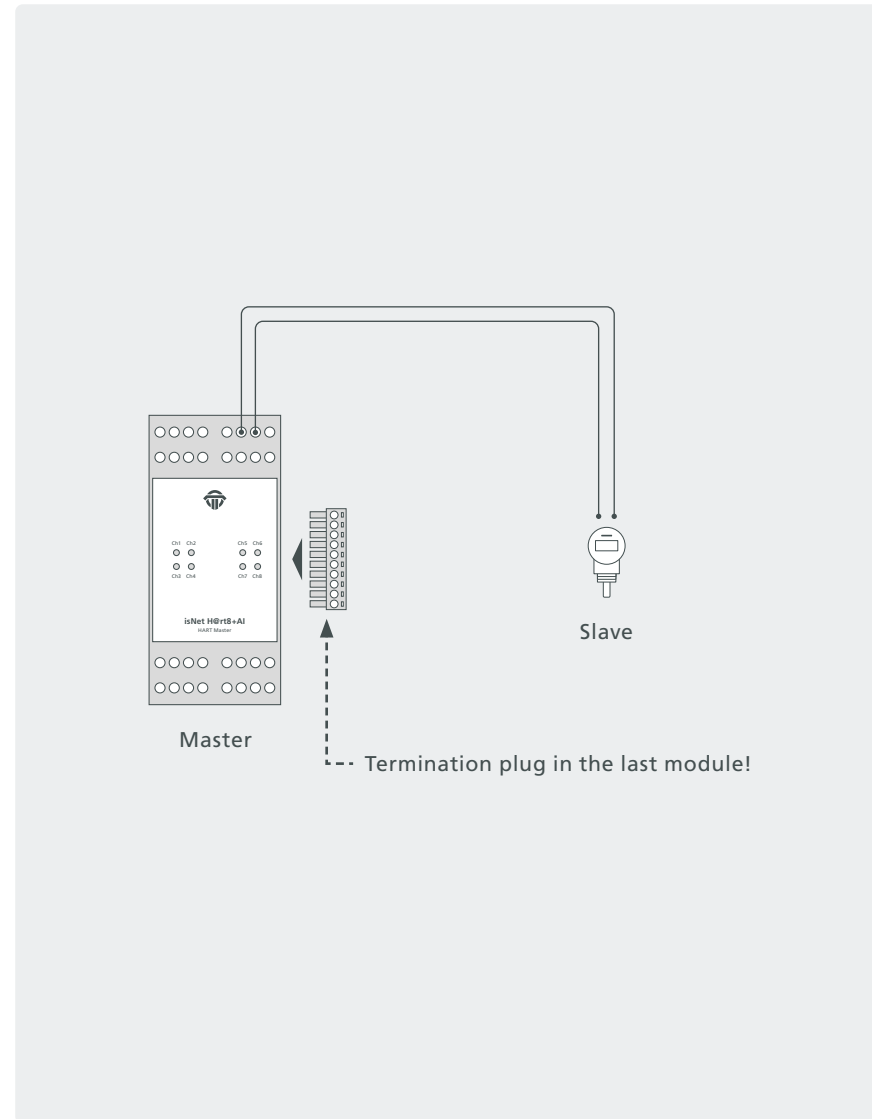

1.7 isNet FF / isNet FF2 / isNet FF4

The isNet FF modules can be used to connect to FOUNDATION Fieldbus H1 Segments. The modules are Link Master devices, capable of acting as a LAS. There exist 3 different versions of these modules, with 1 channel, with 2 channels or with 4 channels.

The 1-channel module includes a Fieldbus power supply including a power conditioner for FOUNDATION Fieldbus.

The delivery content includes a communication DTM that allows use of the isNet FF modules for asset management, maintenance, parameterisation and configuration of FOUNDATION Fieldbus devices.



1.7.1 Technical details

	1 - Channel isNet FF	2 - Channel isNet FF2	4 - Channel isNet FF4
Connectors	1 screw type terminals	2 screw type terminals	4 screw type terminals
Power consumption ⁽²⁾	2,0W		
LxWxH in mm	114,5 x 45 ⁽¹⁾ x 99	114,5 x 22,5 x 99	114,5 x 45 ⁽¹⁾ x 99
Weight	250 g	xg	xg
Temperature range	- 40° C ≤ T _{amb} ≤ 60° C / -40° F ≤ T _{amb} ≤ 140° F		
Storage temperature	- 40° C ≤ T _{amb} ≤ 85° C / - 40° F ≤ T _{amb} ≤ 185° F		
Transmission rate	31,25 kbit/s		
Driver software	Windows XP, Vista, 7, 8, 10 and 11		
Delivery content	Hardware, isNet DTM Library, Pactware, User manual isNet Line on CD		
Fieldbus supply/channel	300 mA	no	no
Fieldbus supply voltage	22 ... 24V	no	no
Order code	19300-1701	19300-0801	19300-0901

⁽¹⁾ Dimensions without lateral plugs

⁽²⁾ without fieldbus slaves

1.7.2 Channel assignment

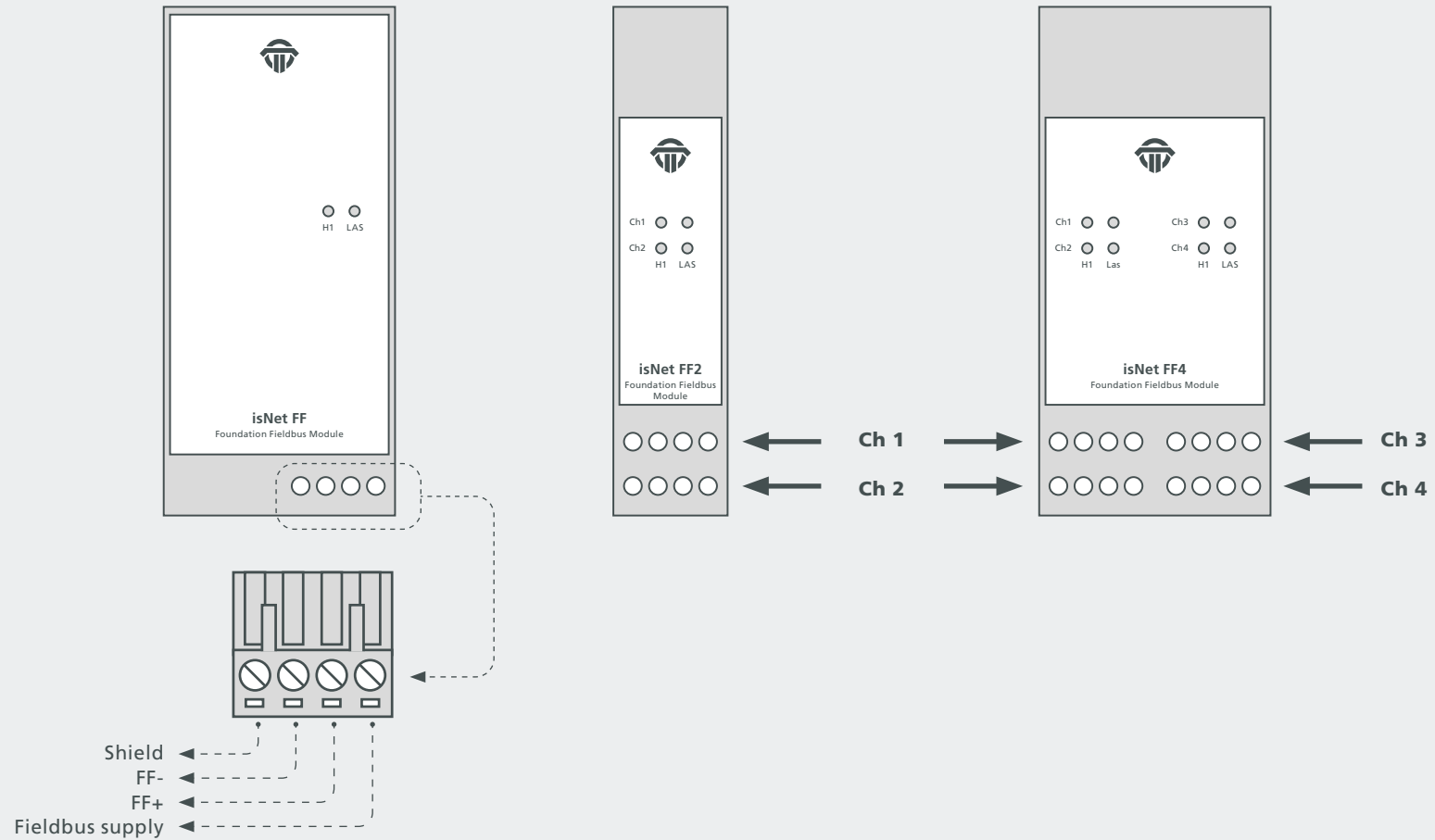

1.7.3 Hardware Installation

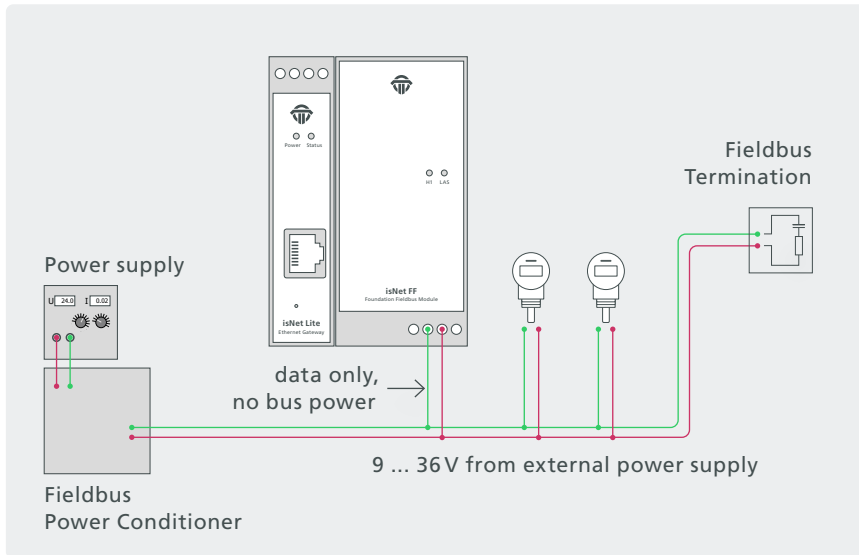

Connection with an external power supply

The FF modules allow you to connect to an existing FF network via the signal lines FF+ and FF-.

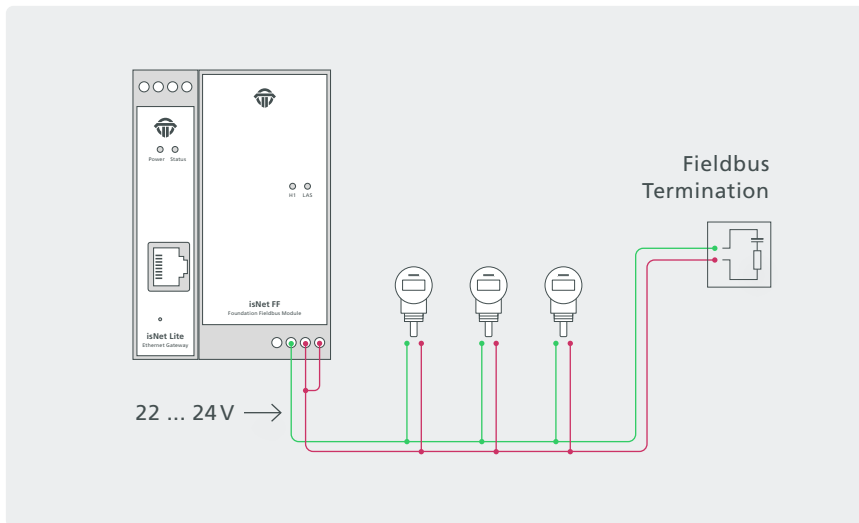

Connection without an external power supply

The FF Fieldbus devices can be powered by the isNet FF.

1.8 isNet DIO

The isNet DIO is a Digital Input/Output expansion module for the isNet Line. The module exists in 2 versions, one with 4 and one with 8 I/O channels. Each channel consists of one 4-pin screw terminal, with one Input and one Output per terminal. Every channel is galvanically isolated individually.

The module does not only read or write binary logic levels, but every channel can also be configured to operate with more sophisticated functions like counter, timer, frequency measurement or PWM output. The resulting process variables are directly accessible over Profinet or Modbus-TCP.

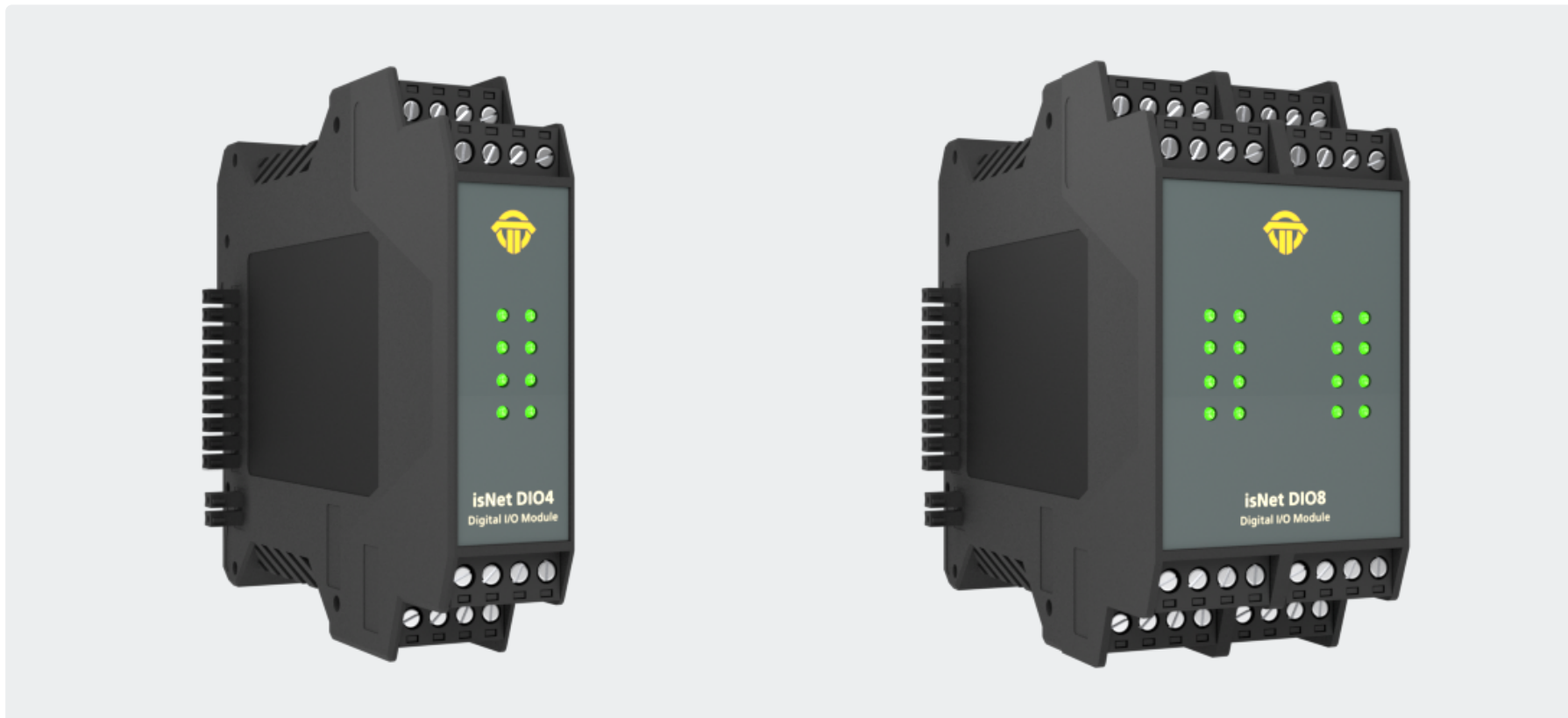

1.8.1 Technical details

	4-Channel isNet DIO4	8-Channel isNet DIO8
Connectors	4 screw type terminals	8 screw type terminals
LxWxH in mm	114,5 x 22,5 ⁽¹⁾ x 99	114,5 x 45 ⁽¹⁾ x 99
Power consumption	1 W	1 W
Weight	140 g	250 g
Temperature range	- 40° C <= T _{amb} <= 70° C / - 40° F <= T _{amb} <= 158° F	
Storage temperature	- 40° C <= T _{amb} <= 85° C / - 40° F <= T _{amb} <= 185° F	
Pollution degree	2	
Altitude	up to 2000 m	
Wire size	0,2 mm ² ... 2,5 mm ² /AWG24 ... AWG 12 ⁽⁴⁾	
Order code	19300-1301	19300-1404

⁽¹⁾ Dimensions without lateral plugs

⁽⁴⁾ Cable entries and field wiring must be suitable for an operating temperature of at least +20°C above ambient.

Digital Inputs

input voltage range	-30V ... 30V
max. input frequency	100 Hz
switching levels	
0:	-30V ... 5V
1:	15V ... 30V

Digital Outputs

ON		resistance:	< 1 Ohm
		maximum current:	500 mA
OFF		resistance:	> 40 MOhm
		maximum voltage:	30V
switching frequency			100 Hz

1.8.2 Channel assignment

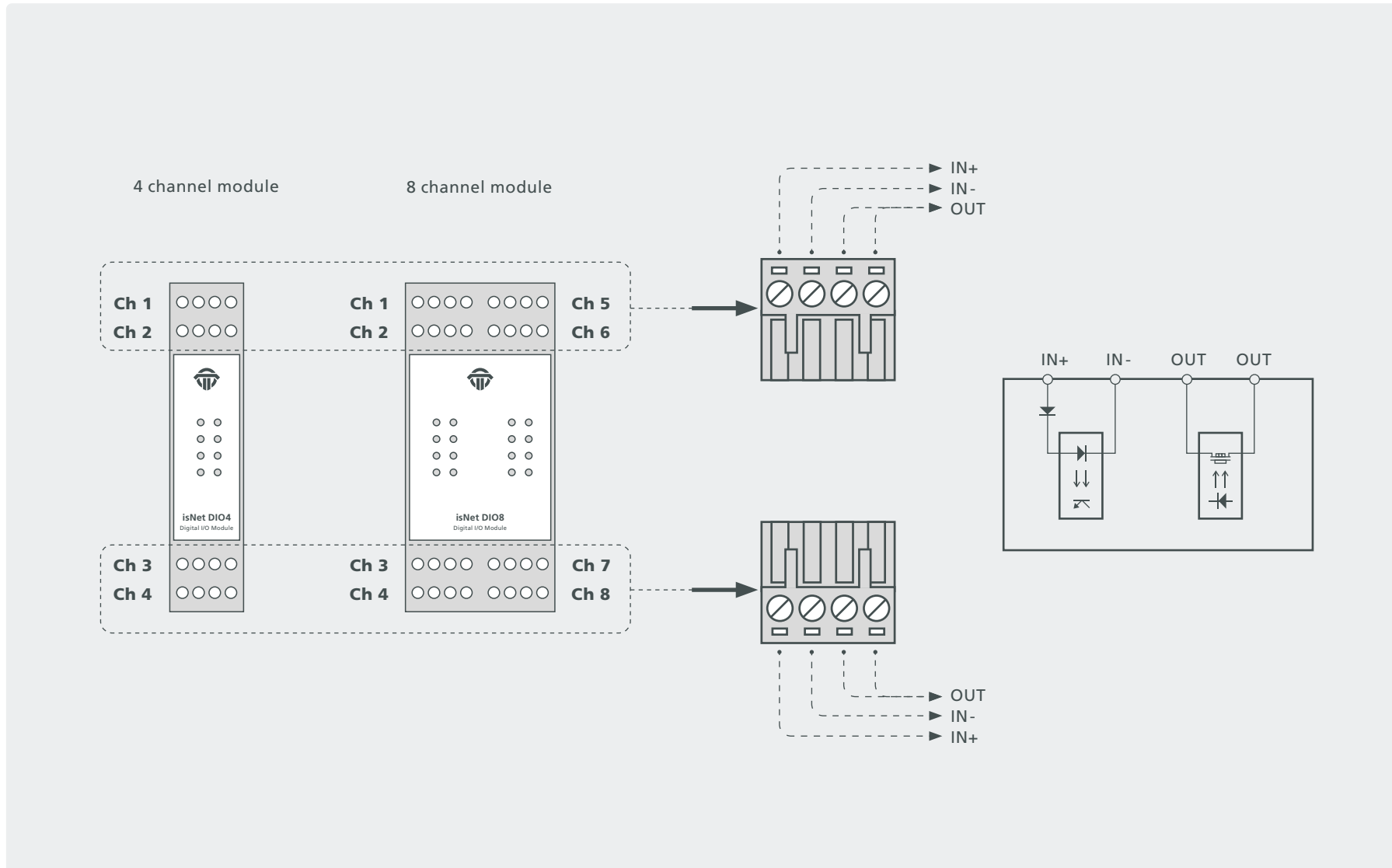

1.9 isNet PAMon and DPMon

With the isNet DPMon and isNet PAMon modules the head module isNet Lite can be enhanced by diagnosis and protocol monitor functions. The modules detect and diagnose sporadically occurring problems during data transmission on a PROFIBUS network. The modules identify configuration problems in the transmission protocol as well as electrical faults that cause interruptions.

The DP monitor module offers one channel that can be connected to the PROFIBUS network via a D-SUB 9 connector. The PA monitor module offers two channels working independently from each other that can be connected to the PROFIBUS network via screw-type terminals. Both monitor modules work totally passive; no telegrams are sent to the bus. The modules evaluate the status of all stations on the bus and provide a concise overview about it if needed. In this view the bus status of every single layer of the OSI reference model is separately detected and can also be addressed separately.

The modules also offer a protocol monitor, an integrated 200 MHz oscilloscope and an extensive analysis of statistical data, e.g. error counters or average time intervals. Long term monitoring allows autonomous operation for a long period of time even if the Net Lite is not connected to the PC. The protocol file is saved on a memory card and can later be downloaded to a PC.

The accompanying software isField Diagnosis (see page 71) is used to access the diagnosis functions.

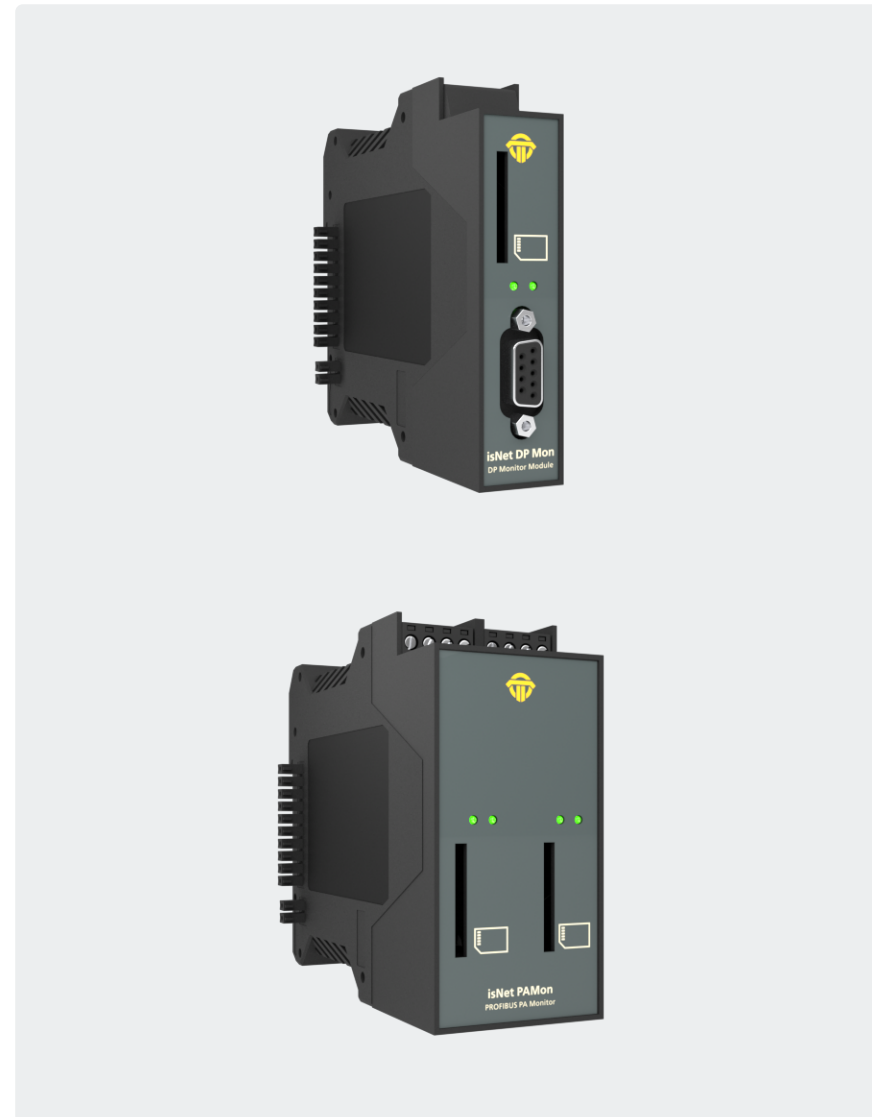

1.9.1 Technical details

	isNet DPMon	isNet PAMon
Connectors	1 RS-485	2 screw type terminals
LxWxH in mm	114,5 x 22,5 ⁽¹⁾ x 99	114,5 x 45 ⁽¹⁾ x 99
Power consumption	2,5W	2,4W
Weight	140 g	250 g
Temperature range	0° C <= T _{amb} <= 50° C / 32° F <= T _{amb} <= 122° F	
Transmission rate	9,6 kBit/s ... 12 Mbit/s	31,25 kBit/s
Driver software	Windows 2000, XP, Vista, 7, 8, 10 and 11	
Delivery content	Hardware, isNet DTM Library, isFieldDiagnosis Setup, Pactware, User manual isNet Line on CD	
Order code	19300-0201	19300-0301

⁽¹⁾ Dimensions without lateral plugs

1.9.2 Channel assignment

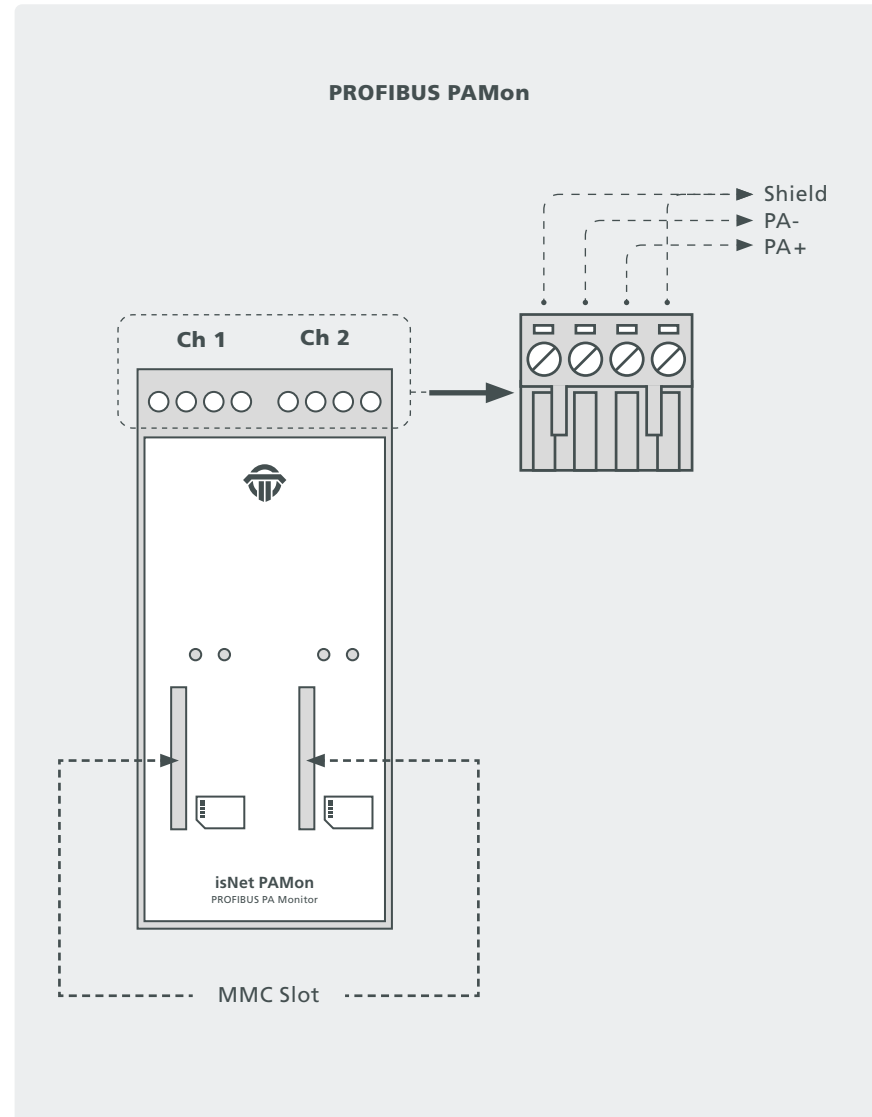
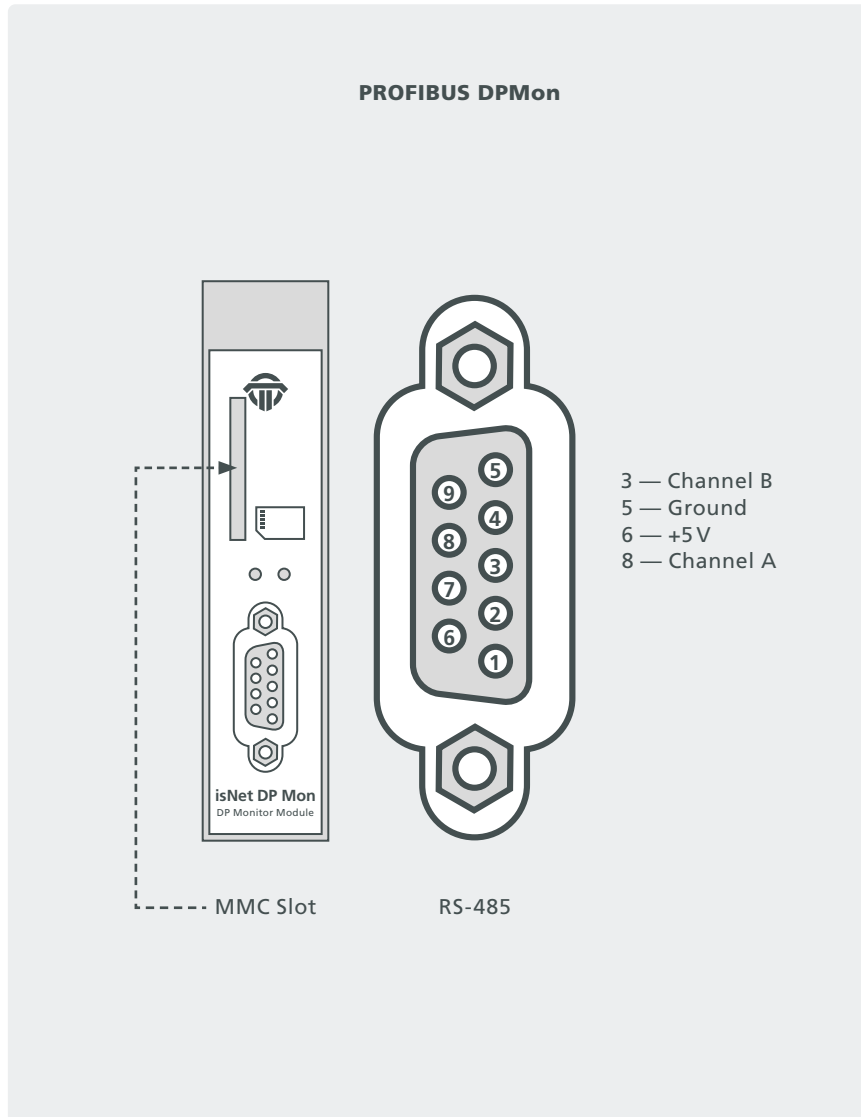

1.10 isNet FFMon

With the isNet FFMon module, the main module isNet Lite can be enhanced by new diagnosis and protocol monitor functions. The module detects and diagnoses sporadically occurring problems during data transmission on a FOUNDATION FIELDBUS network. The module identifies configuration problems in the transmission protocol as well as electrical faults that cause interruptions.

The FF monitor module offers two channels working independently from each other that can be connected to the FOUNDATION FIELDBUS network via screwtype terminals. The monitor works totally passive, no telegrams are sent to the bus. The module evaluates the status of all stations on the bus and provides a concise overview about it if needed. In this view the bus status of every single layer of the OSI reference model is separately detected and can also be addressed separately. The module also offers a protocol monitor, an integrated oscilloscope and an extensive analysis of statistic data, e.g. error counters or average time intervals. Long term monitoring allows autonomous operation for a long period of time even if the isNet Lite is not connected to the PC. The protocol file is saved on a memory card and can later be downloaded to a PC.

The accompanying software isField Diagnosis (see page 71) is used to access the diagnosis functions.



1.10.1 Technical details

	isNet FFMon
Connectors	2 Screw terminals
LxWxH in mm	114,5 x 45 ⁽¹⁾ x 99
Power consumption	2,4W
Weight	250 g
Temperature range	0° C <= T _{amb} <= 50° C / 32° F <= T _{amb} <= 122° F
Transmission rate	31,25 kBit/s
Driver software	Windows 2000, XP, Vista, 7, 8, 10 and 11
Delivery content	Hardware, isNet DTM Library, isFieldDiagnosis Setup, Pactware, User manual isNet Line on CD
Order code	19300-0801

⁽¹⁾ Dimensions without lateral plugs

1.10.2 Channel assignment

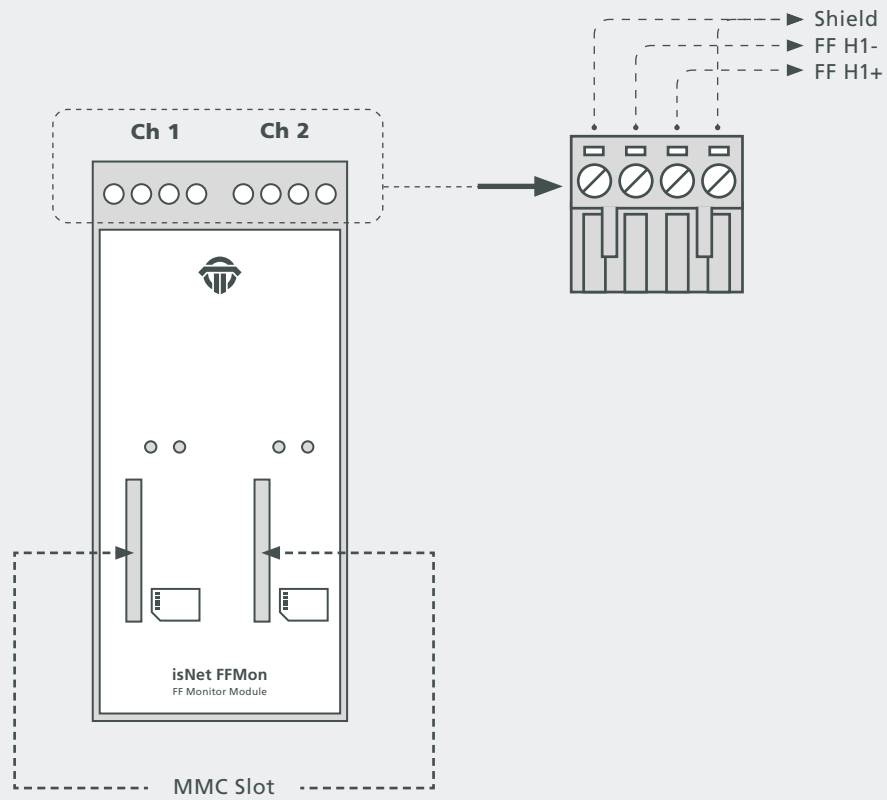

2. Hardware installation

2.1 Safety instructions



Installation notes

Installation, operation and maintenance must be made by qualified personnel only and in accordance with your local and national technical regulations and safety directives.

Do not repair the device yourself, but replace it with an equivalent device. Repairs may be performed by the manufacturer only.

The manufacturer is not legally responsible for damage resulting from failure to comply.

2.2 Mechanical installation

Starting from the left there is always mounted the main module isNet Lite. To the right of isNet Lite up to 5 expansion modules can be connected. A termination plug (standard accessory) has to be

placed at the last expansion module. This termination plug is not intended to connect wires. It contains two resistors that are necessary for communication between head module and expansion modules.

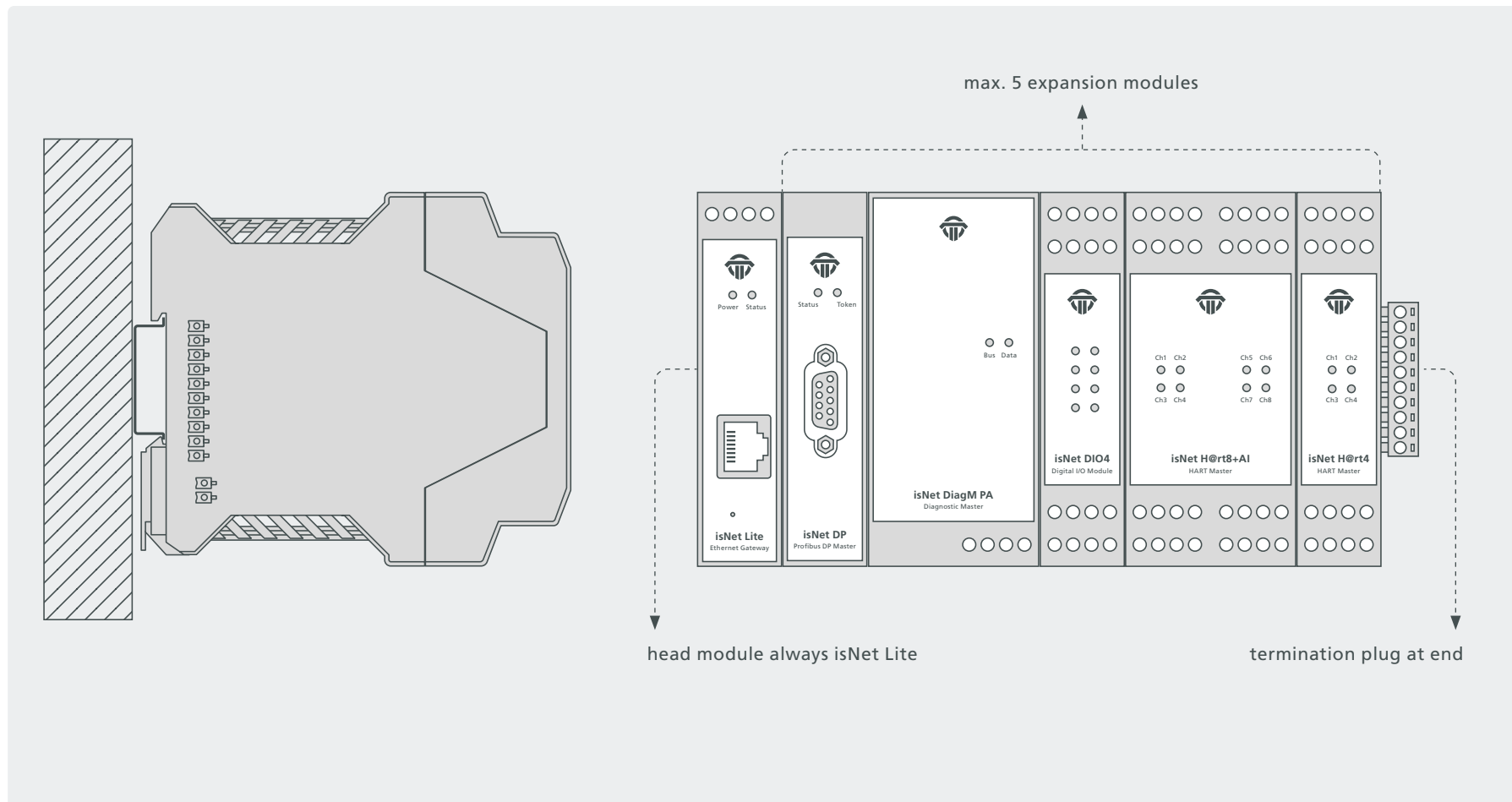

2.2.1 Specific conditions of use



The equipment shall be installed in an enclosure that provides a degree of protection not less than IP 54 in accordance with IEC/EN 60079-15 and that have been considered to be not accessible in normal operation without the use of a tool.

Transient protection shall be provided that is set at a level not exceeding 140 % of the peak rated voltage value at the supply terminals to the equipment.

The modules must be mounted vertically on a 35 mm DIN rail.



The modules of the isNet Line are an open system and in accordance with UL/CSA approval an “open type.” The modules have to be installed in a control cabinet, appropriate housing or a closed electrical operation room accessible only to authorized maintenance staff.

2.3 Electrical installation



Before installation of the modules and wiring make sure that the system is off power.

The supply voltage of 24V is only connected to the main module isNet Lite. The expansion modules are supplied via the backplane bus from the main module.



To supply the modules only power supplies with a secure electrically isolated extra-low voltage (SELV) may be used.



Cable entries and field wiring must be suitable for an operating temperature of at least +20° C above ambient.

Please note:

The isNet Lite head station and your PC need to be in the same IP-address range and therefore in the same subnetmask. If your PC can not locate the isNet Lite it could be due to a firewall. The PC is using UDP broadcasts to locate the isNet Lite. There could also be an issue with UDP broadcast if you have two or more Ethernetcards in your PC.

3. Web Interface

The isNet Lite provides a web interface for startup operation, settings and maintenance. The layout consists of a top area with a view of the actual module configuration, a menu on the left side that is depending on the currently selected module and an information/settings area. On the top of the page the website shows the actual configuration of all modules currently connected to the isNet Lite.

If the pictures do not match the actual module configuration, then the isNet Lite was not able to recognise the attached modules correctly. In this case please check the termination plug (see ch. 2 "Hardware installation"). The pictures are clickable to select the fieldbus modules. Depending on the selected module the menu on the left side will show menu items related to the kind of the selected module.



3.1 Configuration of the IP address

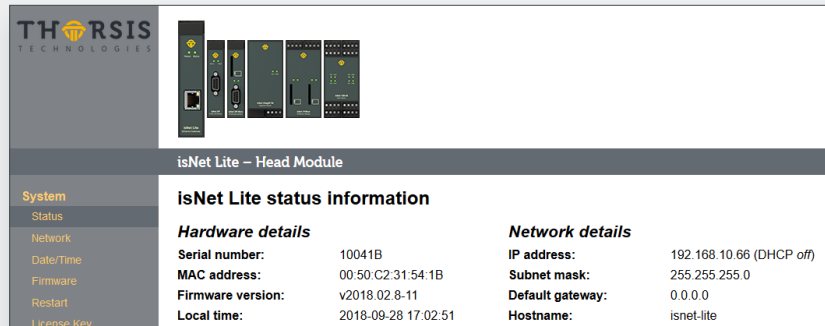

The screenshot shows the THORSIS logo and a navigation menu on the left. The main content area is titled "isNet Lite - Head Module" and "isNet Lite status information". It is divided into two columns: "Hardware details" and "Network details".

Hardware details		Network details	
Serial number:	10041B	IP address:	192.168.10.66 (DHCP off)
MAC address:	00:50:C2:31:54:1B	Subnet mask:	255.255.255.0
Firmware version:	v2018.02.8-11	Default gateway:	0.0.0.0
Local time:	2018-09-28 17:02:51	Hostname:	isnet-lite

The default address of the module is: 192.168.0.10 subnet mask 255.255.255.0 Use your favorite browser to go the IP Address of your isNet Lite Headstation. You should see this website. This is a overview over the current status.

Click on „Network Settings“ and you will get to the configuration mask.

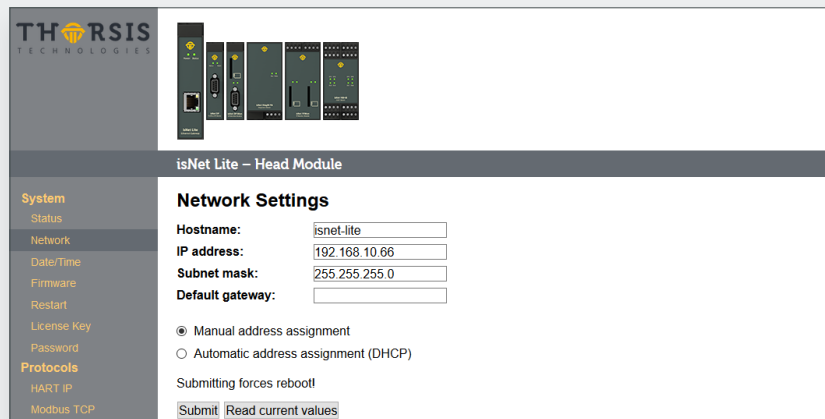

The screenshot shows the THORSIS logo and a navigation menu on the left. The main content area is titled "isNet Lite - Head Module" and "Network Settings". It contains input fields for Hostname, IP address, Subnet mask, and Default gateway. There are also radio buttons for "Manual address assignment" (selected) and "Automatic address assignment (DHCP)". A "Submit" button and a "Read current values" button are at the bottom.

Hostname:

IP address:

Subnet mask:

Default gateway:

Manual address assignment
 Automatic address assignment (DHCP)

Submitting forces reboot

Here you can change the Hostname, the IP Address, the subnet mask and the default Gateway. You can also choose to set the IP Address manually or with your DHCP Server. Pressing the Submit button applies the changes and restarts the headstation.

3.2 Update of the Firmware

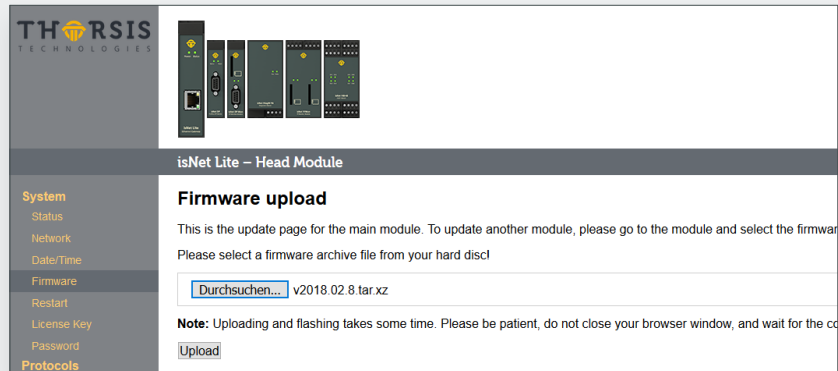

If a new firmware is available for your device you can flash it using the web interface. Go to the Menu Firmware and select the file you want to flash. Click the Upload button and wait until a confirmation appears that the upload was successful.

After the successful update, the isNet Lite must be restarted by using the Restart function in the Web interface.

3.3 Soft-Restart

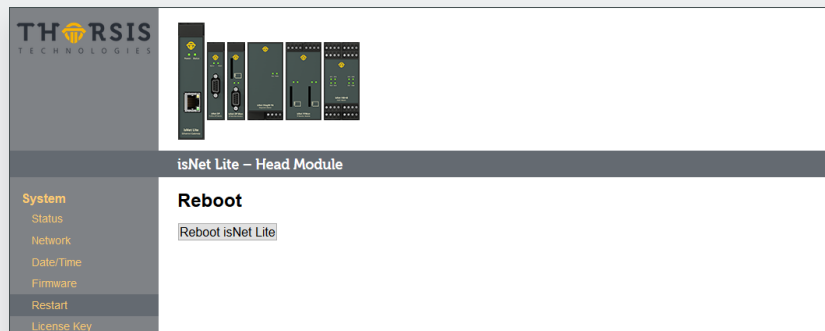

To restart the module, go to the Restart menu and press the button Reboot.

3.4 Password Protection

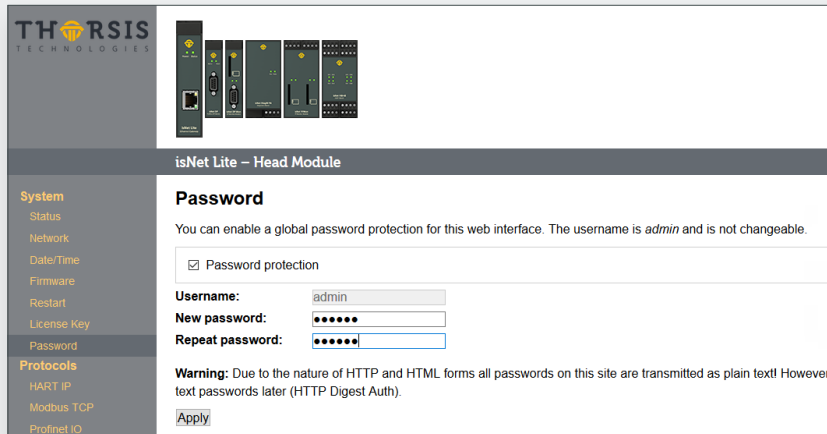

The screenshot shows the THORSIS TECHNOLOGIES web interface for the isNet Lite Head Module. The left sidebar contains a menu with categories: System (Status, Network, Date/Time, Firmware, Restart, License Key, Password) and Protocols (HART IP, Modbus TCP, Profinet IO). The main content area is titled "isNet Lite – Head Module" and "Password". It includes a checkbox for "Password protection" which is checked. Below this are three input fields: "Username" with the value "admin", "New password" with masked characters, and "Repeat password" with masked characters. A "Warning" message states: "Due to the nature of HTTP and HTML forms all passwords on this site are transmitted as plain text! However, we will support text passwords later (HTTP Digest Auth)." An "Apply" button is located at the bottom of the form.

To enable a global password protection for the isNet Lite web interface, click on the Password menu on the left. Activate the Password protection by clicking in the checkbox. Enter your password and repeat it in the field below.

Click Apply to confirm your settings.

Please note, that the username is always admin and can not be changed.

3.5 Activating MODBUS functionality

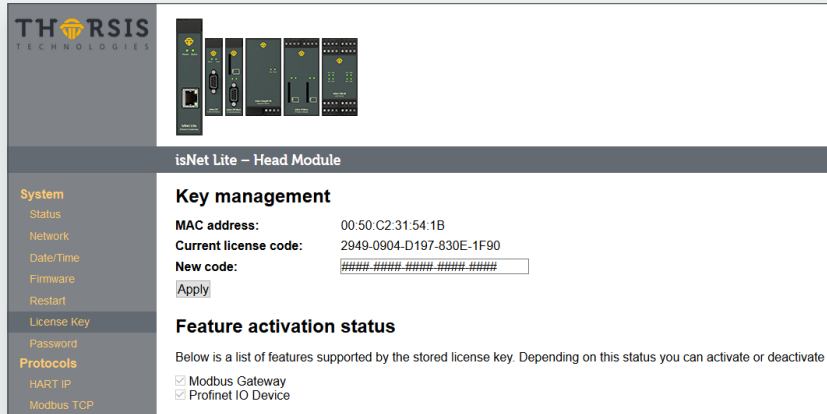

The screenshot shows the THORISIS Technologies web interface for the 'isNet Lite - Head Module'. The left sidebar contains a navigation menu with the following items: System (Status, Network, Date/Time, Firmware, Restart), License Key, Password, Protocols (HART IP, Modbus TCP), and Modbus Gateway. The main content area is titled 'Key management' and displays the following information:

- MAC address:** 00:50:C2:31:54:1B
- Current license code:** 2949-0904-D197-830E-1F90
- New code:** A text input field containing a series of hash symbols (#).
- Apply:** A button to save the changes.

Below the 'Key management' section is the 'Feature activation status' section, which includes the text: 'Below is a list of features supported by the stored license key. Depending on this status you can activate or deactivate c'. It contains two checked checkboxes: 'Modbus Gateway' and 'Profinet IO Device'.

To unlock the MODBUS functionality, you need to enter a valid license code. Go to the License Key page and enter the key. After clicking Apply, the MODBUS feature will be activated. Enable the MODBUS gateway by clicking Activate MODBUS Gateway.

3.6 MODBUS status

The screenshot shows the THORSIS Technologies web interface. The top left corner features the THORSIS TECHNOLOGIES logo. Below it, a navigation menu lists various system settings: System, Network, Date/Time, Firmware, Restart, License Key, Password, Protocols, HART IP, Modbus TCP, Profinet IO, and Contact. The main content area is titled 'isNet Lite - Head Module' and displays the 'Modbus Gateway' configuration page. The 'Status' section indicates 'Modbus Gateway not running' with a yellow warning box. Below this, there are buttons for 'Enable Modbus Gateway' and 'Disable Modbus Gateway'. The 'Fieldbus Configuration' section includes a 'Configuration File Usage' area with a checked checkbox for 'Use FCML file for mapping' and an 'Apply' button. The 'Current Configuration' section shows 'Fieldbus configuration file present' with details for 'Last modified: 1970-01-01 01:35' and 'File size: 1K', and a 'Download' button. The 'New Configuration' section prompts the user to 'Select a FCML file from your hard disc' and includes a file selection button labeled 'Durchsuchen...' and the text 'Keine Datei ausgewählt.', along with an 'Upload' button.

The menu MODBUS Gate shows an overview of the MODBUS status. You can upload a FCML configuration file here.

3.7 HART over IP

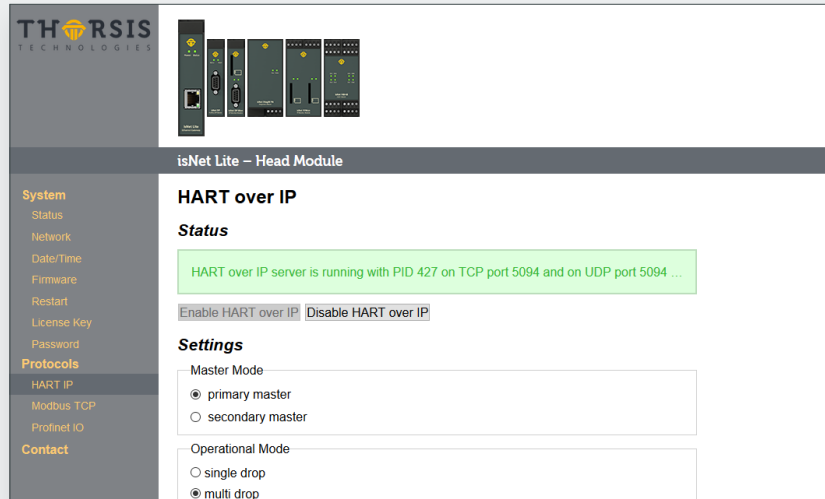

The screenshot displays the THORSIS Technologies web interface for the 'isNet Lite - Head Module'. The left sidebar contains a navigation menu with categories: System (Status, Network, Date/Time, Firmware, Restart, License Key, Password), Protocols (HART IP, Modbus TCP, Profinet IO), and Contact. The main content area is titled 'HART over IP' and includes a 'Status' section with a green message: 'HART over IP server is running with PID 427 on TCP port 5094 and on UDP port 5094 ...'. Below the status are two buttons: 'Enable HART over IP' and 'Disable HART over IP'. The 'Settings' section is divided into 'Master Mode' (with radio buttons for 'primary master' and 'secondary master') and 'Operational Mode' (with radio buttons for 'single drop' and 'multi drop').

Enable or disable HART over IP at this menu. It also shows the current status of the HART over IP functionality.

4. FDT Configuration



We also provide a CommDTM for FDT Frame Applications. To install the CommDTM you need to install the „isNet H@rt DTM Setup.exe“ from the CD-Rom. After that you have to start your FDT-Frame Application and it will update its DTM database.

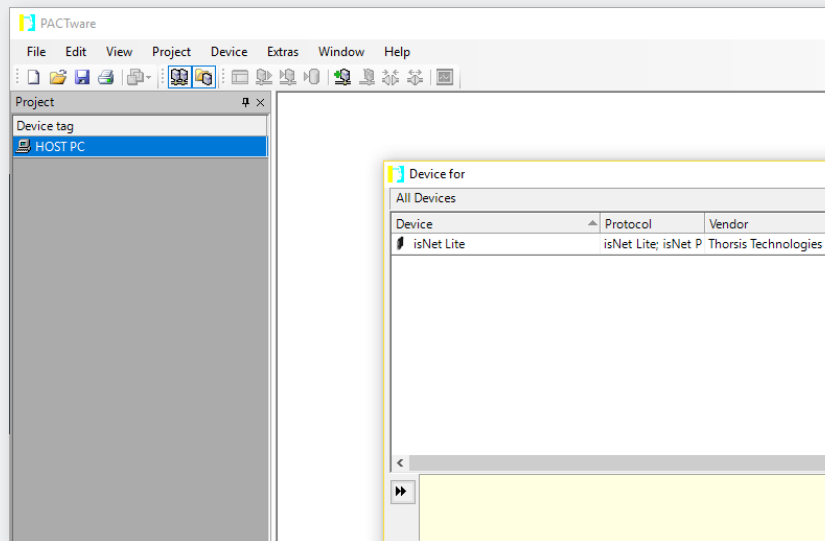

The FDT Frame Application PACTware is used in this manual as an example. Once you have opened your FDT Frame Application and started a new project you can add the isNet Lite as device. You just need to select it and it will be added to your project.

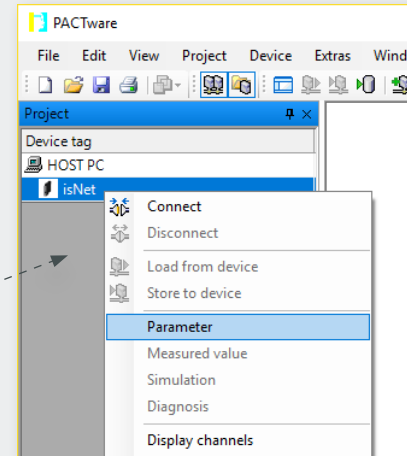
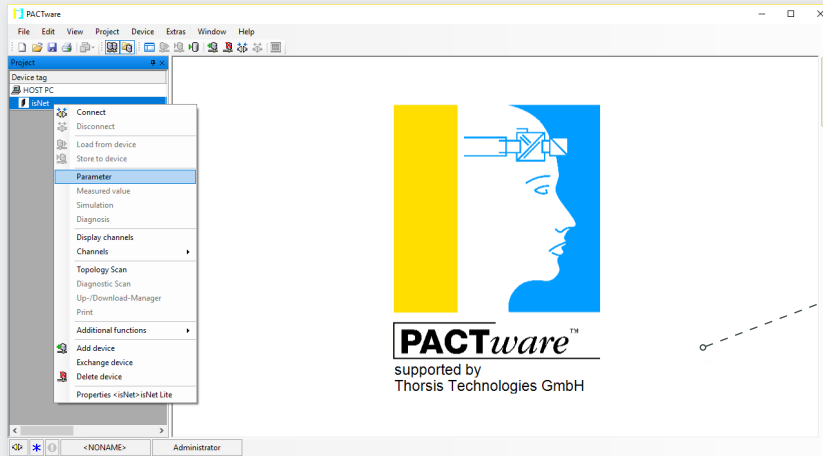

The next step is to right click on the isNet Lite and select Parameter.

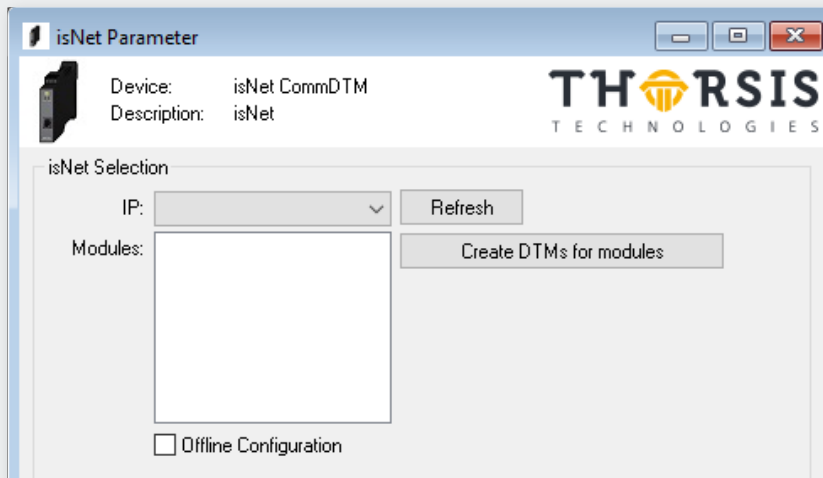

You can now select the correct IP address of the isNet Lite. Just click on the Drop-Down-List as shown. The dialog will show all attached modules. If you click on „Create Child DTM“ they will be added to your project below the isNet Lite.

If you are using Fieldcare instead of PACTware this process might fail and you need to add them manually.

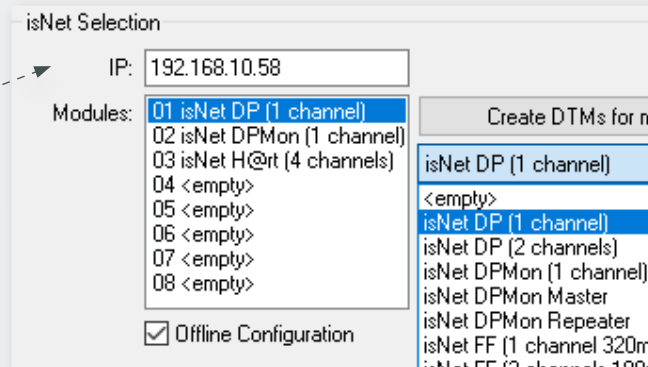
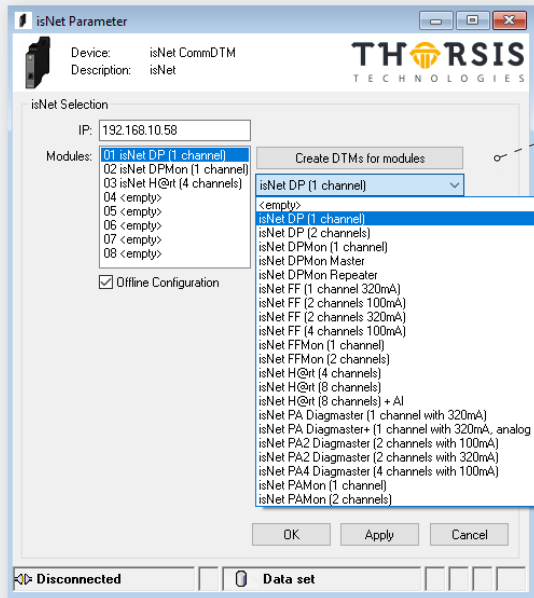

If the CommDTM could not find any isNet Lites or if the isNet Lite is offline you are able to configure it offline. You just need to click the check box „Offline Configuration“. Then enter the IP address manually and select the attached modules in the right order manually.

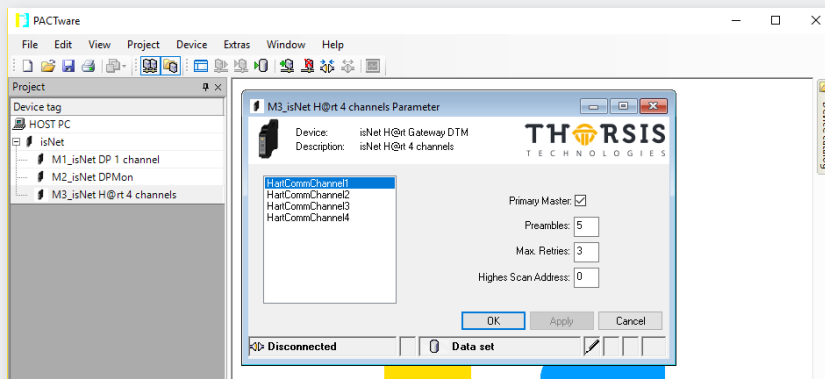

Add a Child DTM to the isNet DTM if not done previously. The Device catalogue will offer a list of installed isNet Lite modules. Select the right module type and, after that, open the Parameter dialog to make the fieldbus related settings.

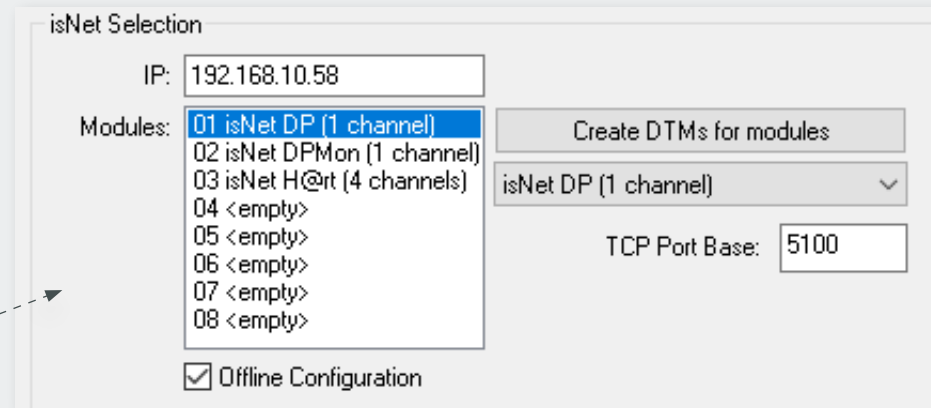

Now you can add a DeviceDTM to the isNet DTM. A dialog will show up where you can select the physical channel to which the device is connected.

5. isNet Lite – PROFINET



The PROFINET Gateway is a combination of the Ethernet headstation isNet Lite and the proven PROFIBUS and HART-master expansion modules of the product line. The implementation of the gateway firmware was done according to the profile „Fieldbus Integration into PROFINET IO 2.0“ of PROFIBUS International.

By means of a corresponding GSDML, it is easily integrated into PROFINET-based automation solutions. By connecting the corresponding fieldbus modules, up to 40 HART or 10-PROFIBUS-channels are available.

A particular highlight are the expansion modules isNet PA2 and PA4, which allow a direct connection to up to 4 PA lines per module. Together with the isNet Lite, the process area on the field level can be directly accessed through the PROFINET backbone. The previously required use of a DP / PA segment coupler is no longer necessary.

5.1 Workflow of the engineering process

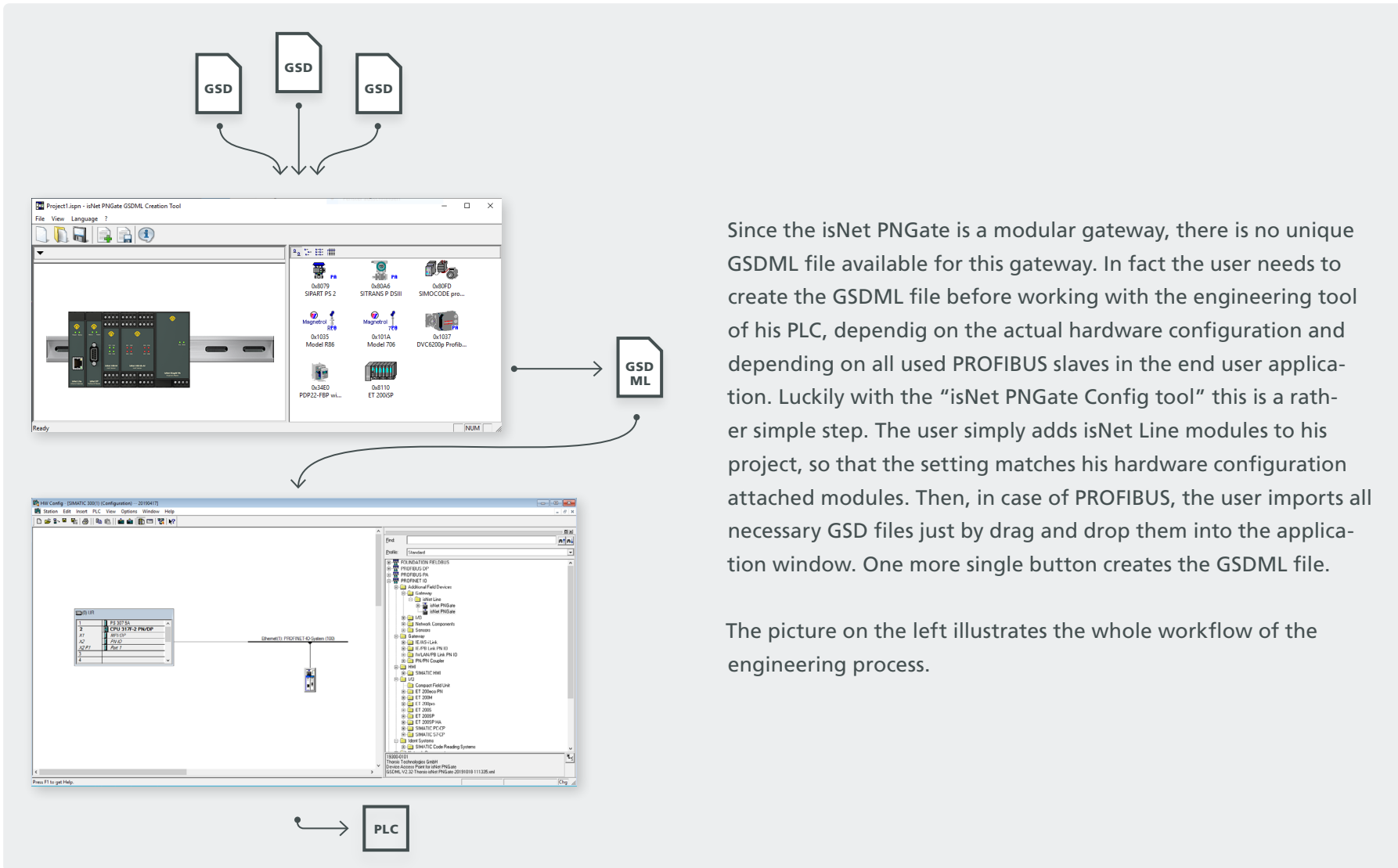

Since the isNet PNGate is a modular gateway, there is no unique GSDML file available for this gateway. In fact the user needs to create the GSDML file before working with the engineering tool of his PLC, depending on the actual hardware configuration and depending on all used PROFIBUS slaves in the end user application. Luckily with the "isNet PNGate Config tool" this is a rather simple step. The user simply adds isNet Line modules to his project, so that the setting matches his hardware configuration attached modules. Then, in case of PROFIBUS, the user imports all necessary GSD files just by drag and drop them into the application window. One more single button creates the GSDML file.

The picture on the left illustrates the whole workflow of the engineering process.

5.2 Creation of the GSDML file

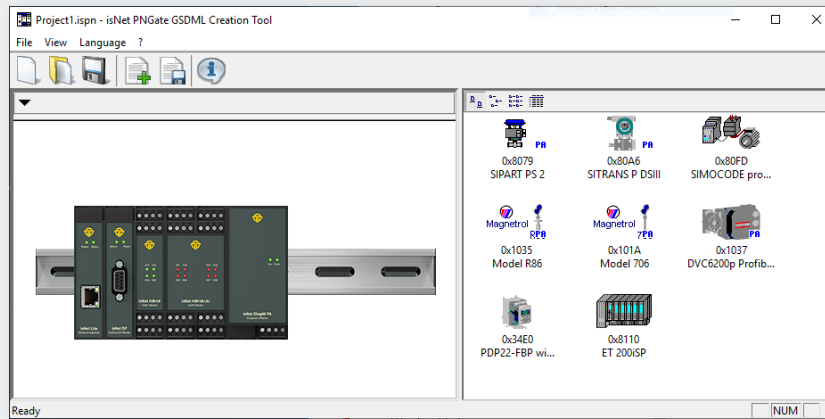

With the „isNet PNGate Config tool“ the creation and configuration of a GSDML file is a quite simple step. The tool consists of a single, stand-alone executable file and does not need to be installed on the PC. It can be run directly from the CD or any other storage medium.

5.2.1 Step 1: Configuration of modules

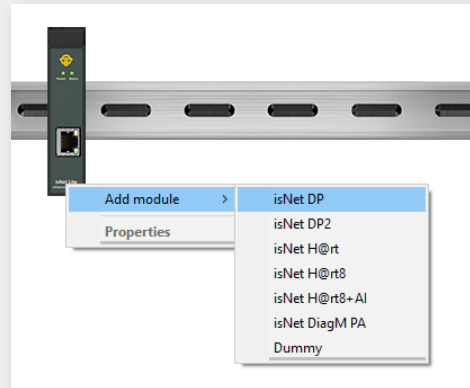

The user needs to add modules to the project to match the configuration with the actual hardware of isNet Line modules. Adding modules is possible by using the context menu on the isNet Lite picture (the Ethernet head module) or by opening the module catalog and clicking on the desired module.

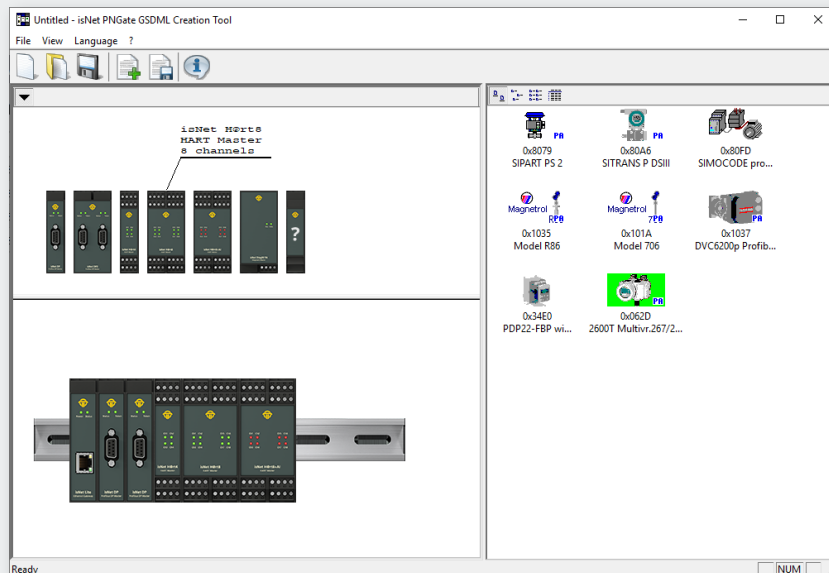

Module catalog opened

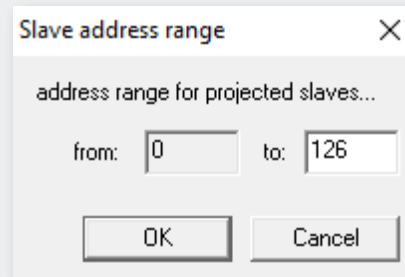
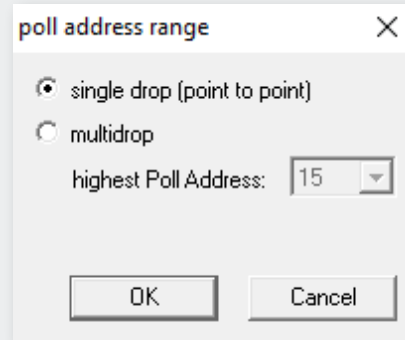
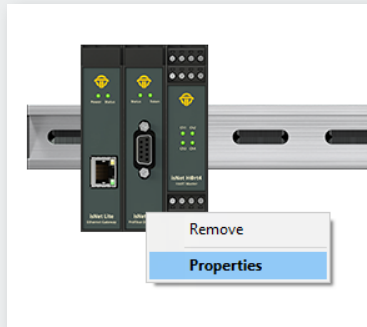

To limit the number of PROFINET slots for better resource usage, the user can set limits to the address range used by PROFIBUS and/or HART modules (in case of multidrop). By using the context menu (or doubleclick) on the appropriate module, the corresponding dialog window will open.

To remove a module from a configuration, just open the context menu on the module and select "Remove".

According to the „Fieldbus Integration into PROFINET IO 2.0“ guideline of PROFIBUS International, every field device (e.g. PROFIBUS slave) occupies one PROFINET Slot in the final engineering project. With up to 126 possible slave addresses for PROFIBUS, one single module like the 4 channel “isNet PA4” module might occupy up to

more than 500 PROFINET slots, and with up to 5 supported modules in the project, the total amount of PROFINET slots might increase to much more than supported by small PLCs. Therefore it might be necessary to limit the address ranges of the attached Fieldbus modules.

5.2.2 Step 2: Configuration of PROFIBUS slaves

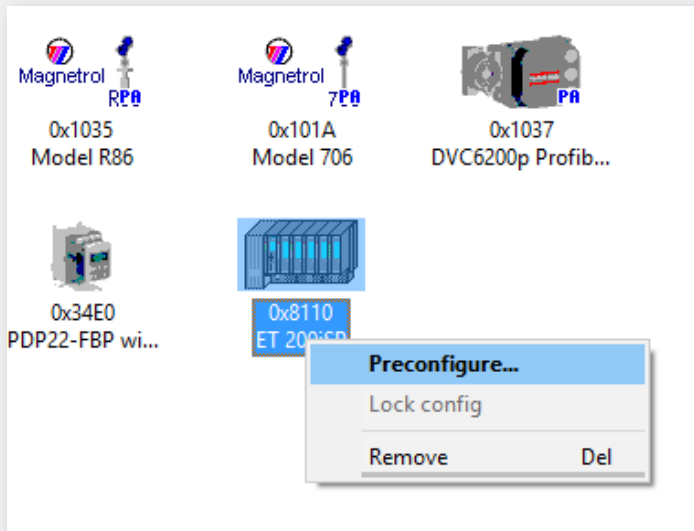

To make use of PROFIBUS slaves, the user needs to import the necessary GSD files into the GSDML project. This is possible by using the menu item "Import GSD..." of the "File" menu, by clicking on the appropriate toolbar button or by dragging the GSD files from any Explorer window of Windows into the slave list frame of the "isNet PNGate Config tool". Please note that the slave list frame remains disabled as long as there is no PROFIBUS Mastermodule added into the project configuration.

By using the context menu or by doubleclick on the PROFIBUS slave icon, the user may preconfigure the modules of the PROFIBUS slave.

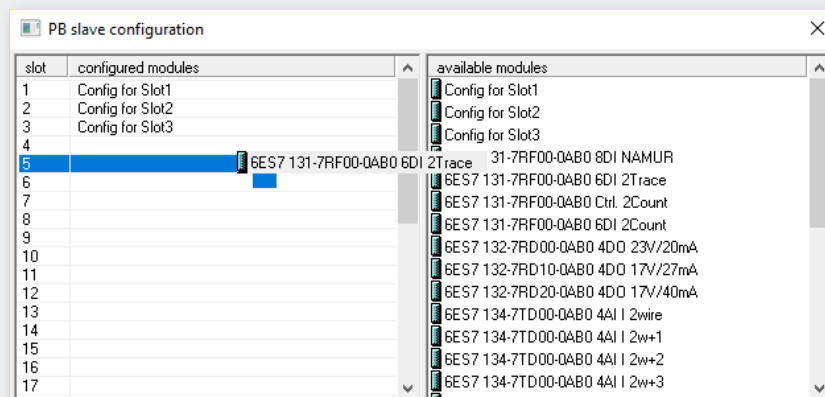

Preconfiguration is useful if the user has several slaves of the same type in the final engineering project, all with the same module configuration. Preconfiguration saves him to configure every single slave in the engineering tool of the PLC.

5.2.3 Step 3: Export of the GSDML file

	module 1	module 2			
	isNet DP	isNet H@rt			
	ch 1	ch 1	ch 2	ch 3	ch 4
Slave address	Profinet slots				
0	6	133	134	135	136
1	7				
2	8				
3	9				
4	10				
5	11				
6	12				
7	13				
8	14				
9	15				
10	16				

Export of the GSDML file is done with a single mouse click on the appropriate toolbar button or by using the "Export GSDML..." menu item of the "File" menu. The following "Save as..." dialog already suggests a proper file name for the GSDML file.

Together with the GSDML file the tool generates 2 more files. One file is the symbol picture, that is used in the engineering tool to be displayed for the isNet PNGate. The other file is a HTML page with a table, that tells the user the relationship between fieldbus slave address of the underlying fieldbusses and PNIO slots in the engineering tool of the PLC.

5.3 Integration in SIMATIC Manager

After creation of the GSDML file, the user can start the engineering process in the engineering tool of his PLC. This chapter shows this process with the example of SIMATIC Manager.

5.3.1 Import of the GSDML file

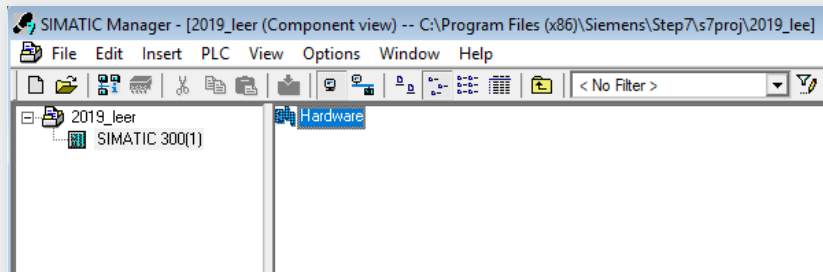

In the SIMATIC Manger project please open the HW Config Window by double-clicking on the Hardware item.

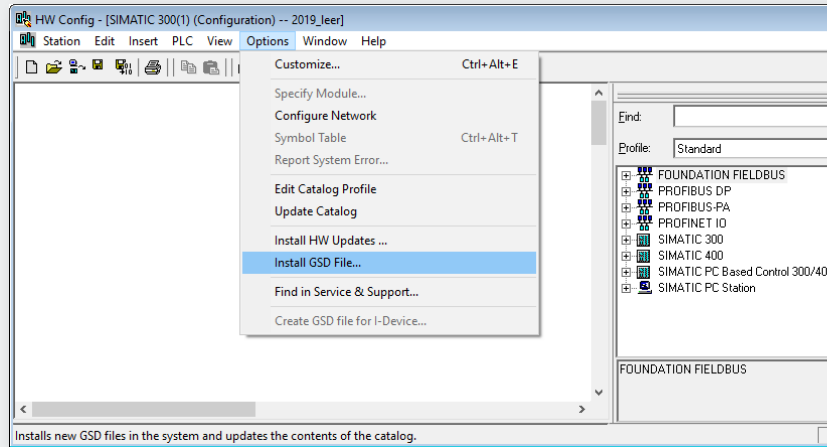

In the HW Config Windows please select menu item „Options -> Install GSD file...“.

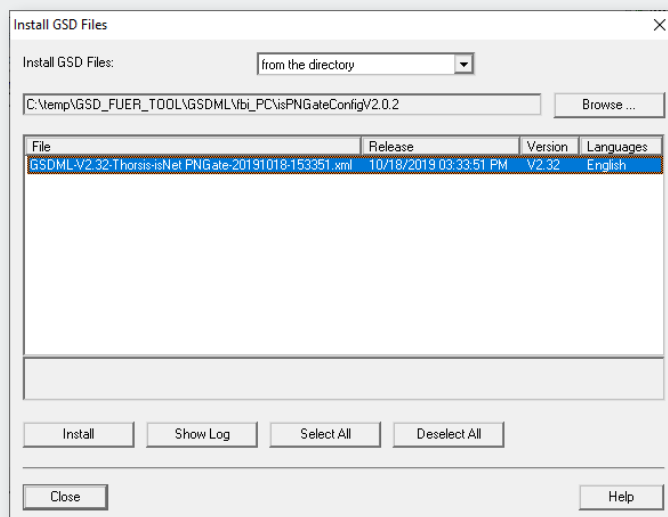

In the following Dialog browse to the folder on your storage medium with the GSDML file, select the GSDML and select the button „Install“.

HW Config - [SIMATIC 300(1) (Configuration) -- 20190417]

Station Edit Insert PLC View Options Window Help

Ethernet(1): PROFINET-IO-System (100)

Slot	Module	Order number	I Address	Q address	Diagnostic Address	Co...
0	isNet-PNGate	19300-0101			8180*	
X1	Interface				8182*	
F1	RJ45 10/100 Mbit/s				8184*	
1	isNet-DP	19300-0A01			8184*	
2	isNet H@rt	19300-0B01			8183*	
2.1	Channel 1				8183*	
2.2	Channel 2				8182*	
2.3	Channel 3				8181*	
2.4	Channel 4				8180*	
3						
4						
5						
6						
7						
8						

Press F1 to get Help.

FOUNDATION FIELDBUS
 PROFIBUS DP
 PROFIBUS-PA
 PROFINET IO
 Additional Field Devices
 Gateway
 isNet Line
 isNet PNGate
 isNet PNGate
 2600T Multiv. 267/269 2010TC
 DVC6200p Profibus PA
 HART Slave Device PV
 HART Slave Device PV/SV/TV/QV
 Model 706
 Model R86
 PDP22-FBP with UMC100
 SIMOCODE pro V PDM (GSD V1.5)
 SIPART PS 2
 SITRANS P DSIII
 I/O
 Network Components
 Sensors
 Gateway
 HMI
 I/O
 Ident Systems
 Network Components
 Sensors
 Switching devices
 SIMATIC 300
 19300-0101
 Thorsis Technologies GmbH
 Device Access Point for isNet PNGate
 GSDML-V2.32-T Thorsis-isNet PNGate-20191018-153351.xml

After Installation of the GSDML file, the isNet PN-Gate will appear in the Hardware catalog with all underlying modules and submodules.

5.3.2 Setting up properties for isNet PNGate

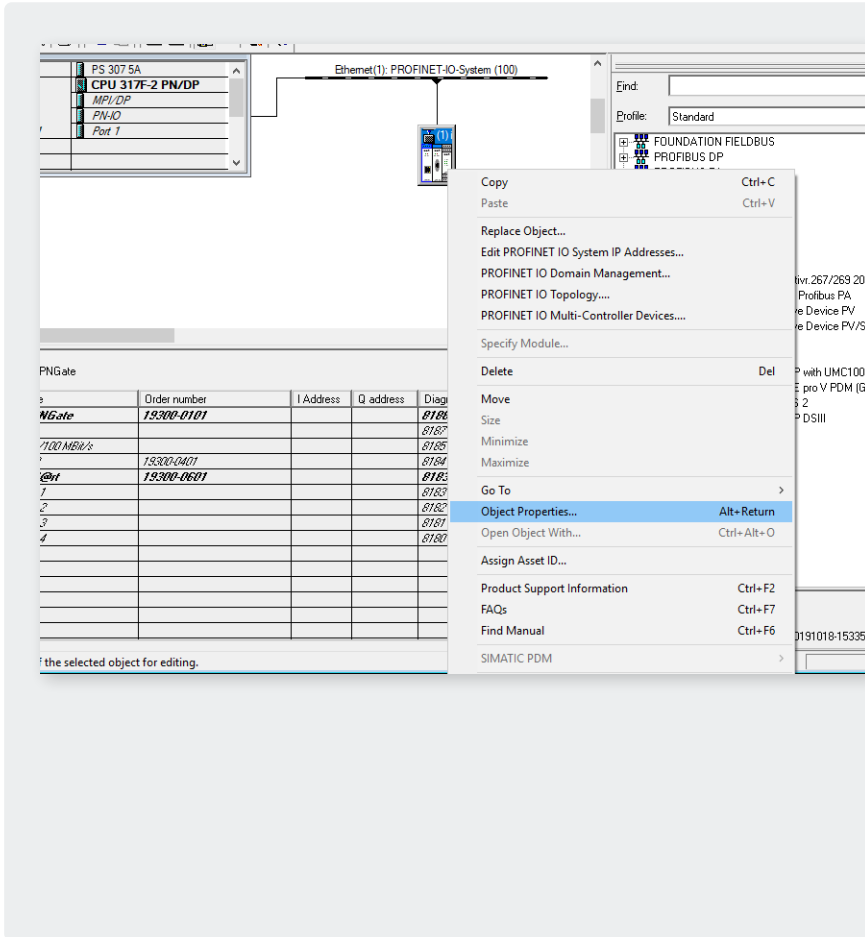

After adding the isNet PNGate into the engineering project, select the menu item „Object Properties...” from the context menu to change PNIO Device name and IP address of the PNIO device. The device name must match the device name, that is stored in the isNet Lite. The Device name can be found on the website of the isNet Lite (please refer to „3. Web Interface” on page 39).

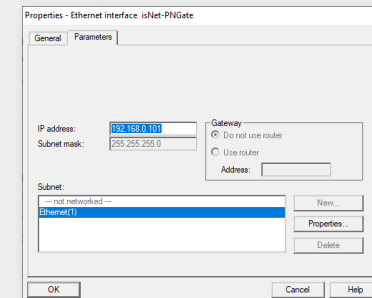
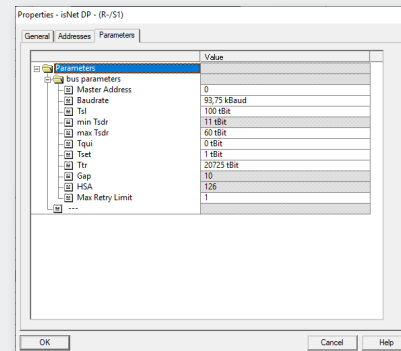

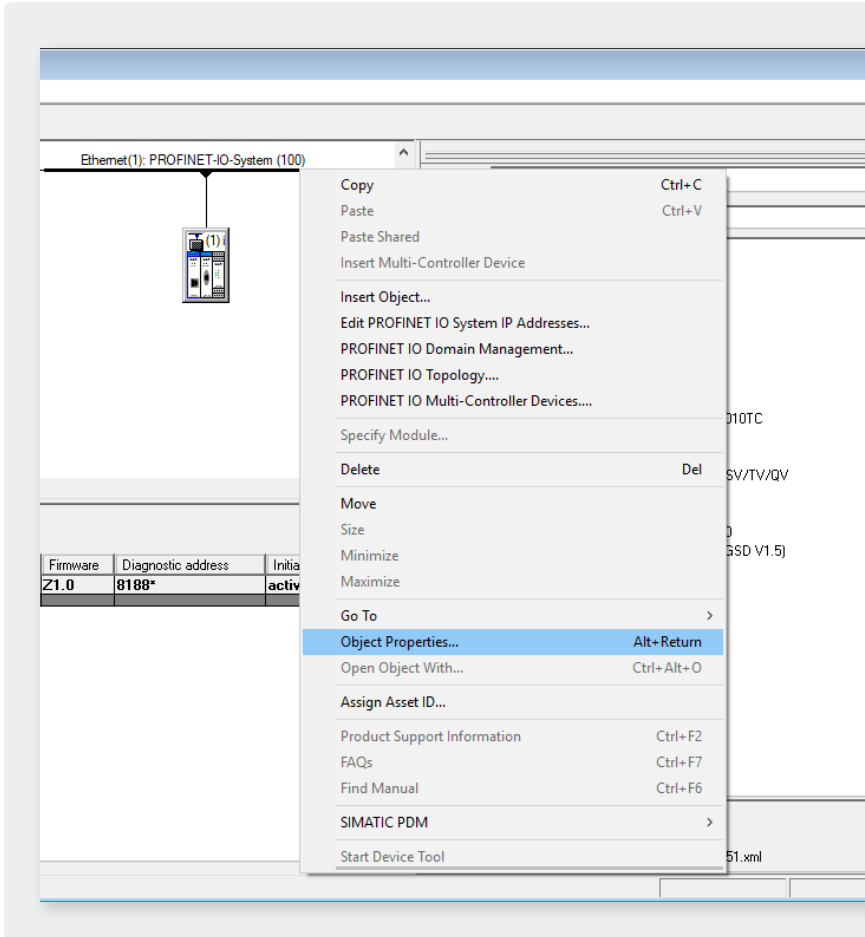

It is recommended to check the Update time for the is- Net PN-Gate. To do so, please select the PROFINET line in the SIMATIC manager and open the context menu. After selection of menu item „Object Properties...“ from the context menu, a dialog windows opens, where the Update time can be edited. The Update time should be set to 128 ms.

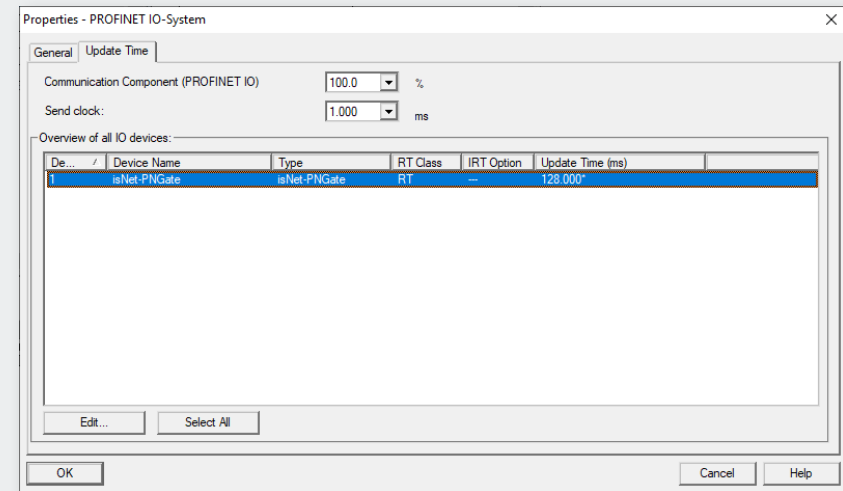

5.3.3 Setting up PROFIBUS

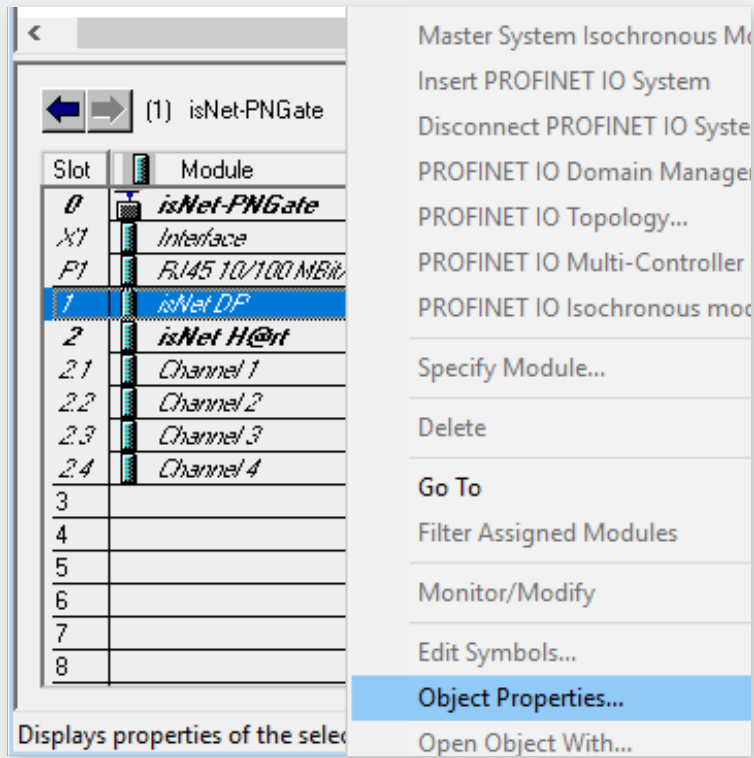

To change the baud rate of a PROFIBUS segment, the Master address or any other bus parameter, please open the context menu of the channel of the PROFIBUS module and select menu item „Object Properties....“.

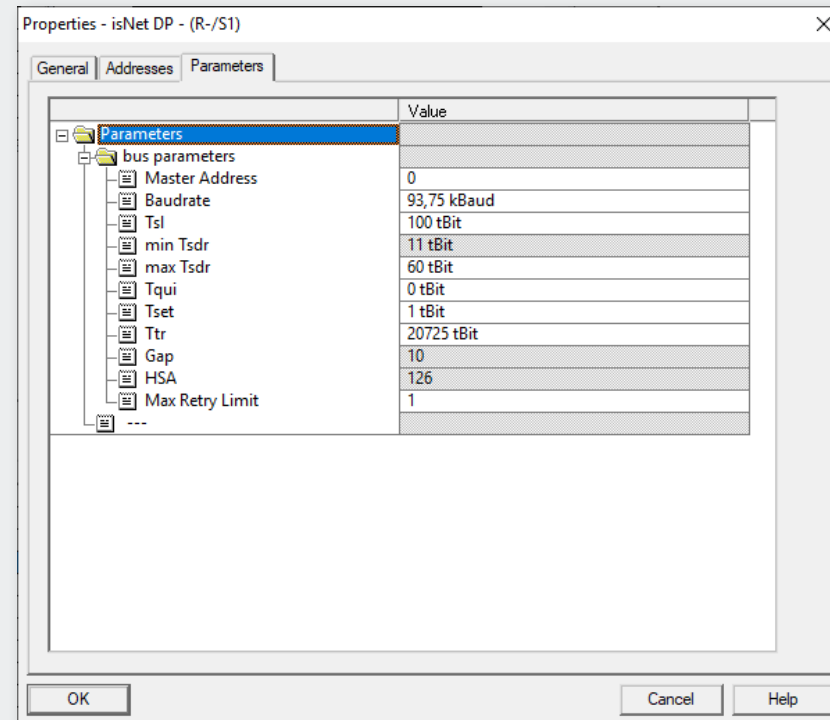

5.3.4 Adding fieldbus slaves to the engineering project

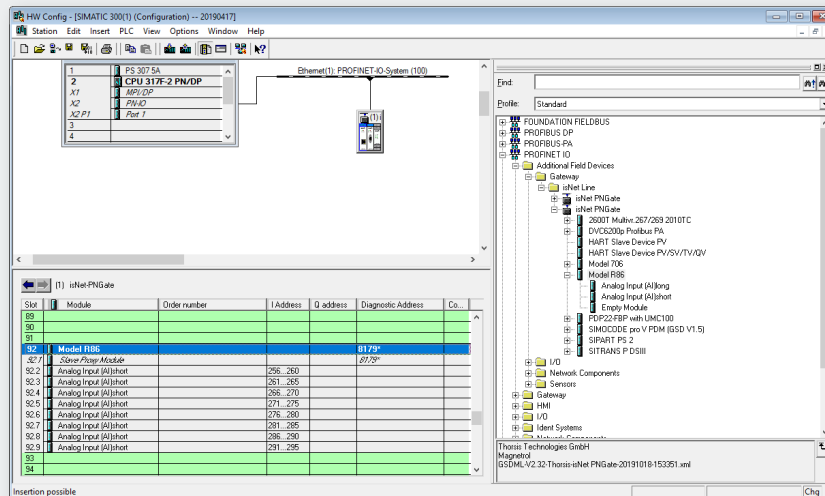

In the hardware catalog, the PROFIBUS slaves and HART slaves appear as modules under the isNet PNGate. To add a fieldbus slave to the project, just drag it into a slot of the isNet PNGate. To determine the appropriate PROFINET slot, the „isNet PNGate Config tool“ also creates a HTML page with a table, that tells the relationship between fieldbus slave address and PNIO slots (please refer to 5.2.3 for an example). If e.g. there is a PROFIBUS slave attached to channel 1 of module 1 with PROFIBUS slave address 3, then the corresponding slot is 9, so the user needs to drag the slave to slot 9. After adding the PROFIBUS slave into the appropriate PROFINET slot, the slave modules need to be added to the project. All PROFIBUS slave modules will appear as sub-modules in the hardware catalog. To add PROFIBUS slave modules to the project, these submodules need to be dragged into the corresponding subslots of the slave. To skip this step, the slave can be preconfigured in the „isNet PNGate Config tool“ (see chapter 5.2.2).

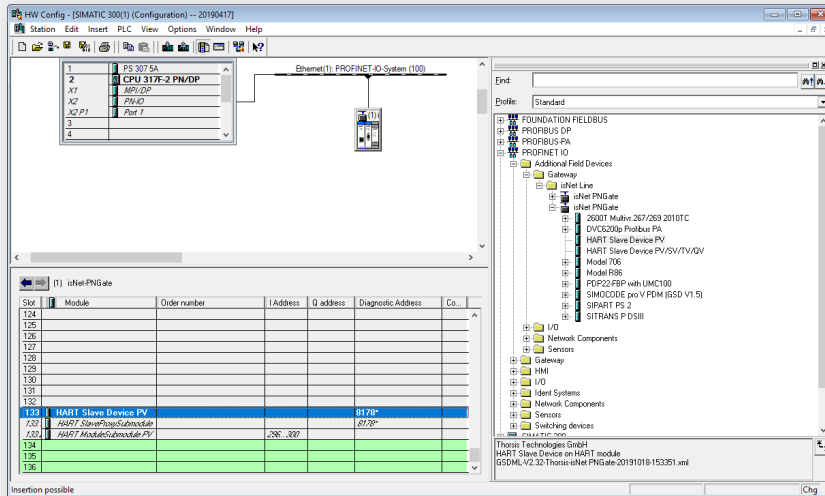

In the next example there is a HART slave attached to the HART module at channel 4. According to the example in chapter 5.2.3 the user needs to drag the HART slave into slot 29.

5.3.5 Parameterisation of PROFIBUS slaves and PROFIBUS modules

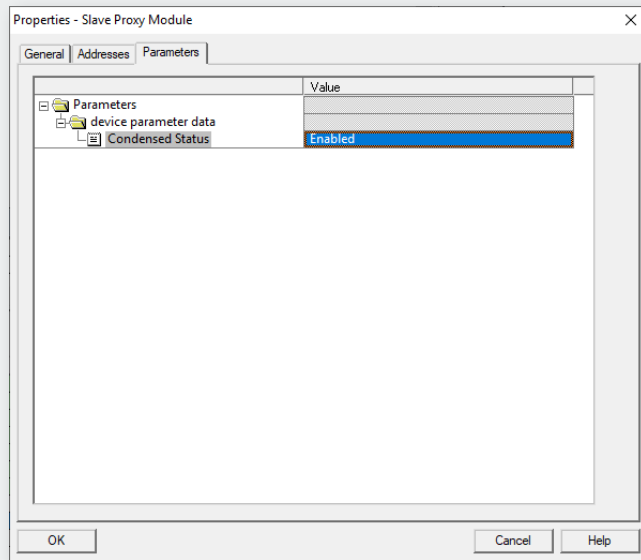

If a PROFIBUS slave provide user specific parameter data, these parameters can be changed. To do so, please double-click on the module or select menu item „Object Properties...” in the context menu of the module.

6. isNet Lite – Modbus



The Gateway isNet Lite is suited for varied tasks in remote operation. Modbus functionality can be enabled in the web interface. See chapter 3 on page 39 for details. Device parameterization, network configuration or diagnosis, data logging and remote control can be done directly from the workstation. The isNet Lite acts as a head module. Up to 5 fieldbus-specific modules (PROFIBUS PA, DP, and HART) or digital I/O modules can be connected, a free combination of the modules is supported. The PROFIBUS DP modules are equipped with one or two bus interfaces (single/dual module), PROFIBUS PA with up to 4 and HART supports up to 8 bus interfaces.

For a detailed description of the Modbus functionality and mapping tables, please see the Thorsis Technologies Modbus manual.

7. isFieldDiagnosis

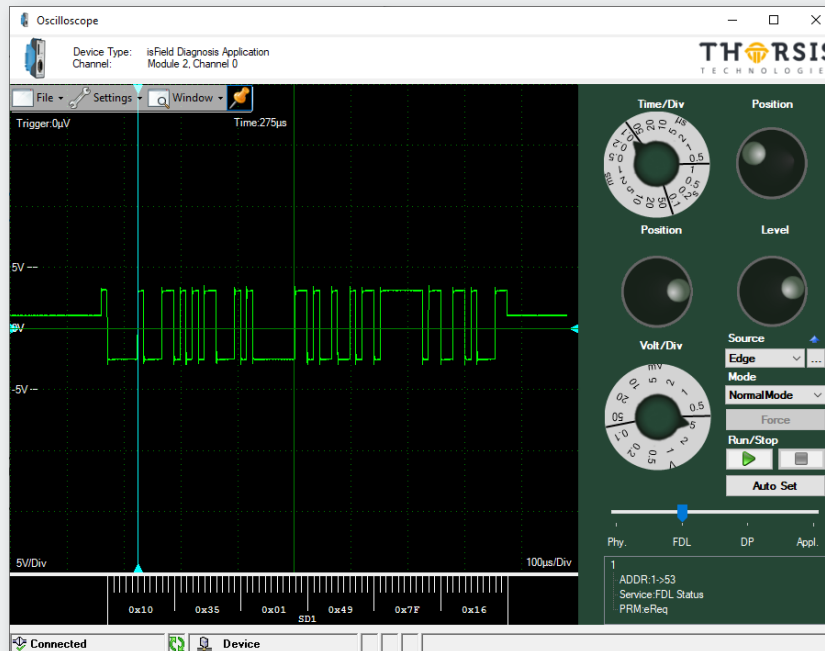

Analog
 PHY
 FDL
 DP
 Appl.

Segment									
0	M1	2	3	4	5	6	7	8	9
10	11	12	13	14	15	16	17	18	19
20	21	22	23	24	25	26	27	28	29
30	31	32	33	34	35	36	37	38	39
40	41	42	43	44	45	46	47	48	49
50	51	52	53	54	55	56	57	58	59

Every isNet Monitoring module comes with the Diagnosis Software DTM isField Diagnosis. The Software shows the status of all stations on the bus and provides a concise overview about it if needed. In this view, the bus status of every single layer of the OSI reference model is separately detected and can also be addressed separately. The software also offers a protocol monitor, an integrated oscilloscope and an extensive analysis of statistic data, e.g. error counters or average time intervals. Sophisticated filter and trigger possibilities restrict the data volume and allow for tailored start and stop conditions of the monitoring.

For a detailed description of the Diagnosis functionality, please see the Thorsis Technologies isFieldDiagnosis manual.

8. Declaration of RoHS Conformity

As a result of our product testing and due to legal requirements (as of December 12, 2019), Thorsis Technologies GmbH confirms that the information below accurately complies with the restrictions on substances according to Directive 2011/65/EU (RoHS2), including phthalates (DEHP, BBP, DBP, DIBP), according to Directive 2015/863/EU and according to Regulation (EC) No. 1907/2006 (REACH-Regulation). With regard to the information contained in this report, Thorsis Technologies GmbH relies on the statements and information provided by its suppliers and service providers. In accordance with DIN EN 50581 the information contained in the report includes a supplier declaration on exemptions and can be used as evidence for the preparation of technical documentation. This information is based on our current knowledge and information provided by our suppliers and is subject to change. Current and future products that comply with the requirements of Directive 2011/65/EU (RoHS 2) will be marked accordingly on our website and packaging.

Thorsis Technologies GmbH does not use in its products none of the substances listed in Annex XVII of the REACH Regulation in concentrations exceeding the limits falling within the scope of the Regulation. In order to ensure a high level of product safety to our customers and to comply with legal requirements, we have reviewed the implementation of the REACH Regulation in accordance with the Candidate List updated on 01.17.2023. According to Article 33 of the REACH Regulation, Thorsis Technologies GmbH is obliged to notify candidate substances that are contained in its products with a mass fraction of more than 0.1%.

9. Document History

Version	Date	Description
1.0	09.05.2018	initial version
1.1	21.11.2018	new texts & images
1.2	04.09.2020	new texts & images
1.3	01.31.2023	added UK Conformity Assessed marking

© Last changed 30. September 2024