isPro USBx12

isPro USBv4

MANUAL



CERTIFICATE OF CONFORMITY

according to EC Directive 2014/30/EU (electromagnetic compatibility) of 26 February 2014.

We hereby declare, that the devices indicated below in there design and construction, are in conformity with the essential safety and health requirements of the EC Directive 2014/30/EU.



CHANGES OR MODIFICATIONS NOT APPROVED BY THORSIS TECHNOLOGIES VOID THE VALIDITY OF THE DECLARATION.

Device type	Order number
isPro USBx12	10300-0401
isPro USBv4	10300-0402

STANDARDS USED: EN 61326-1:2013

Manufacturer

Thorsis Technologies GmbH
Oststr. 18
39114 Magdeburg
Germany

Magdeburg, 2023-01-31

Dipl.-Inf. Michael Huschke,
General Manager

UK DECLARATION OF CONFORMITY

Thorsis Technologies GmbH declares as manufacturer under sole responsibility, that the products down in the list complies with the requirements of following UK legislation:

- S.I. 2019/1246 The Product Safety, Metrology and Mutual Recognition Agreement (Amendment)(EU Exit) regulations 2019
- S.I. 2020/852 The Product Safety and Metrology (Amendment)(EU Exit) regulations 2020
- S.I. 2016/1091 The Electromagnetic Compatibility Regulations 2016
- S.I. 2012/3032 The Restriction of the Use of Certain Hazardous Substances in Electrical and Electronic Equipment Regulations 2012

Device type	Order number
isPro USBx12	10300-0401
isPro USBv4	10300-0402



**CHANGES OR MODIFICATIONS NOT APPROVED
BY THORSIS TECHNOLOGIES VOID THE VALIDITY
OF THE DECLARATION.**

STANDARDS USED: EN 61326-1:2013
CERTIFICATION: NONE

Manufacturer

Thorsis Technologies GmbH
Oststr. 18
39114 Magdeburg
Germany

Magdeburg, January 31, 2023

Dipl.-Inf. Michael Huschke,
General Manager

**UK
CA**

Table of Content

1.	ISPRO USBX12	5
1.1	Technical details	6
1.2	Delivery content	6
2.	ISPRO USBV4	7
1.1	Technical details	8
1.2	Delivery content	8
3.	INSTALLATION AND COMMISSIONING	9
3.1	Installation of the driver software	9
3.2	Installation of the hardware	10
3.2.1	Connection to PROFIBUS DP	11
3.2.2	Connection to PROFIBUS PA	12
3.3	Configuration and commissioning	14
3.3.1	Add a device	15
3.3.2	Add an Empty-Slot	16
3.3.3	Removal of a device	17
3.4	isPro Init Test	17
3.5	isPlorer	18
4.	DOCUMENT HISTORY	19

1. isPro USBx12

Desktop PCs as well as notebook devices without PROFIBUS interfaces can be connected to PROFIBUS stations within seconds. Operational areas are mobile set up and configuration of field devices. The device is USB bus powered and it is not dependent on external power connections.

The interface supports the Master functionality of the PROFIBUS Standard DP (class 1 and 2), DP/V1 (class 2) with a high transmission rate of up to 12 Mbit/s.

The device can be integrated easily into own applications with the uniform API-DLL. or combined with components for the automation standards FDT and OPC.



1.1 Technical details

Interface	isPro USBx12
Controller	MC 68302, ASPC2
RAM	16 kByte dual ported
Connector	1 RS-485
Fieldbus protocols	PROFIBUS DP-(class 1+2) und DP-V1- Master (class 2), DP-Slave, FMS-Master
Transmission rate	9,6 kbit/s ... 12 Mbit/s
Temperature range	0° C ... 60° C
Dimensions	105 x 54 x 30 mm
Driver software	Windows XP, Vista, Windows 7, 8, 10 and 11
Available software	isPro CommDTM (FDT), isPro MultiServer (OPC)

1.2 Delivery content

PROFIBUS-USB-interface „isPro USBx12“, driver-, configuration- and test-software as well as documentation in German and English on USB stick.

Extra: A wall mount for the USB adapter is available on request.

2. isPro USBv4

The isPro USBv4 is the successor of isPro USBx12.

It is compatible with the isPro USBx12.

The isPro USBv4 is optionally available with an isFF/PA MAU media access converter, with which it can be connected to a PROFIBUS PA network.



2.1 Technical details

Interface	isPro USBv4
Controller	Motorola Coldfire
Flash	256 kByte
RAM	256 kByte
Connector	1 RS-485
Fieldbus protocols	PROFIBUS DP-(Kl. 1+2) und DP-V1- Master (Kl. 2), DP-Slave, FMS-Master, PROFIBUS PA (optionally)
Transmission rate	9,6 kbit/s ... 12 Mbit/s (DP), 31,25 kbit/s (PA)
Fieldbus supply	22 ... 24V, max. 15 mA
Temperature range	0° C ... 60° C
Dimensions basic device	105 x 54 x 30 mm
Dimensions media access converter)	36 x 35 x 16 mm
Driver software	Windows XP, Vista, Windows 7, 8, 10 and 11
Available software	isPro CommDTM (FDT), isPro MultiServer (OPC)

2.2 Delivery content

PROFIBUS-USB-interface „isPro USBv4“, driver-, configuration- and test-software as well as documentation in German and English on USB stick.

Optional: media access converter

Extra: A wall mount for the USB adapter is available on request.

3. Installation and commissioning

3.1 Installation of the driver software

The driver software must be installed before connecting the device.

Otherwise, the operating system can not find the interface to the associated driver.

The driver software delivered with our PROFIBUS interfaces permits the access to the PROFIBUS-Firmware under the operating systems Windows XP, Vista and Windows 7, 8, 10 and 11 (32- und 64-Bit). The interface between application and PROFIBUS firmware comes in the shape of a Dynamic Link Library (DLL). The supported operating systems are detected automatically by the driver DLL.

The configuration of the interface can be done with the configuration software isPro Configurator which is installed into the Thorsis directory of the Start Menu.

Installation process:

- Login as administrator.
- Connect the USB stick.
- The setup starts with an autoroutine; proceed according to the instructions displayed on the screen.
Should Autorun be disabled on your machine, run the setup.exe on the USB stick.
- The installation is done in the standard program directory of the target machine under:
C:\Program Files\Thorsis\isPro Multidriver

3.2 Installation of the hardware

The Interface can be connected to the PROFIBUS network with its D-Sub connector directly. With the USB cable the interface can be connected with the PC/notebook.

The device has two LEDs. The right, green LED indicates the presence of the operating voltage. It switches on with the beginning of the initialization.

While initializing or resetting the left LED flashes in red colour. After the end of the initialization/reset process it should darken again. A still flashing red LED indicates the occurrence of an error during start-up/reset. The color yellow shows the correct operating status und signalizes that the interface holds the token.

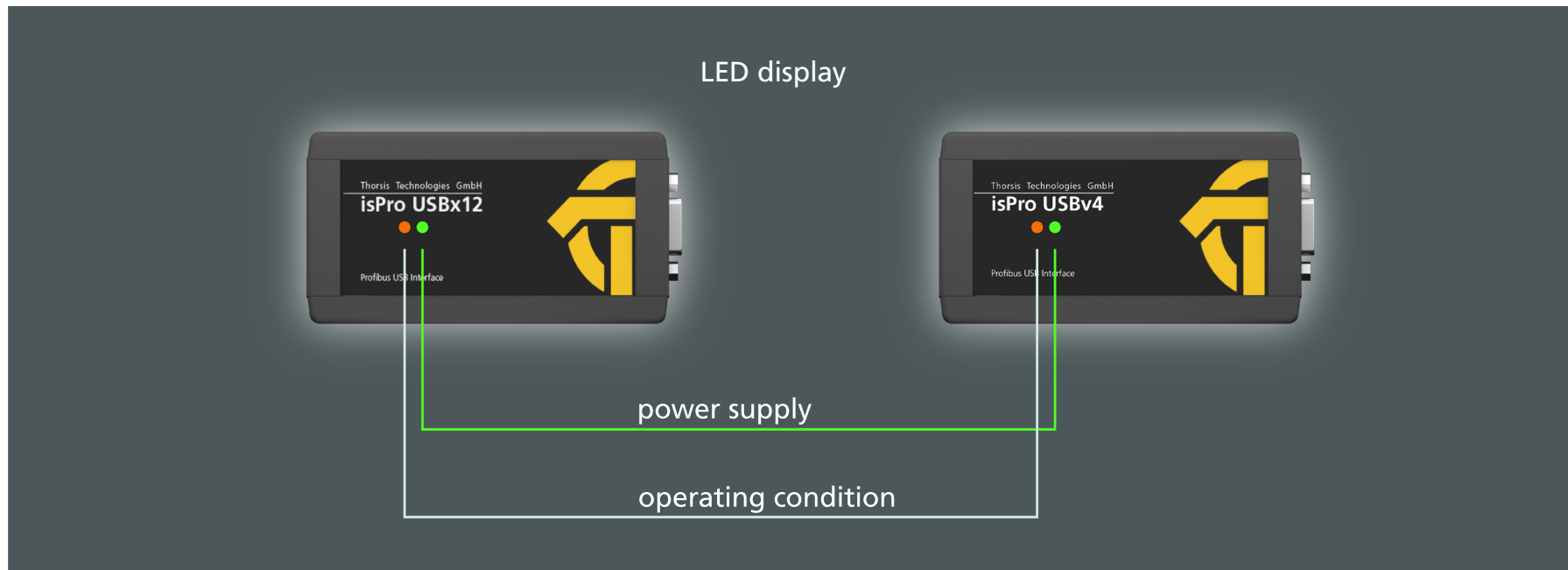

3.2.1 Connection to PROFIBUS DP

Connection to PROFIBUS DP with isPro USBx12 or isPro USBv4.

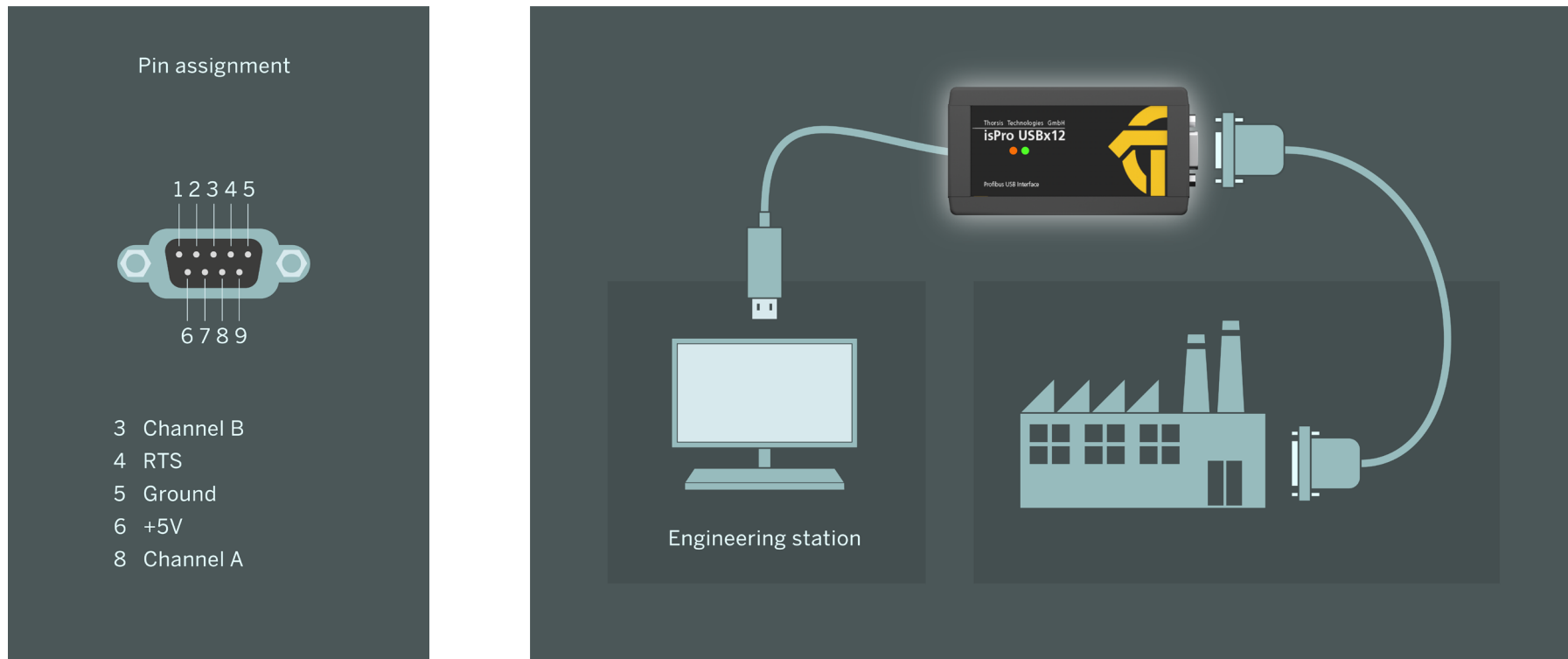

3.2.2 Connection to PROFIBUS PA

Connection to PROFIBUS PA with optional media converter only supported by isPro USBv4.

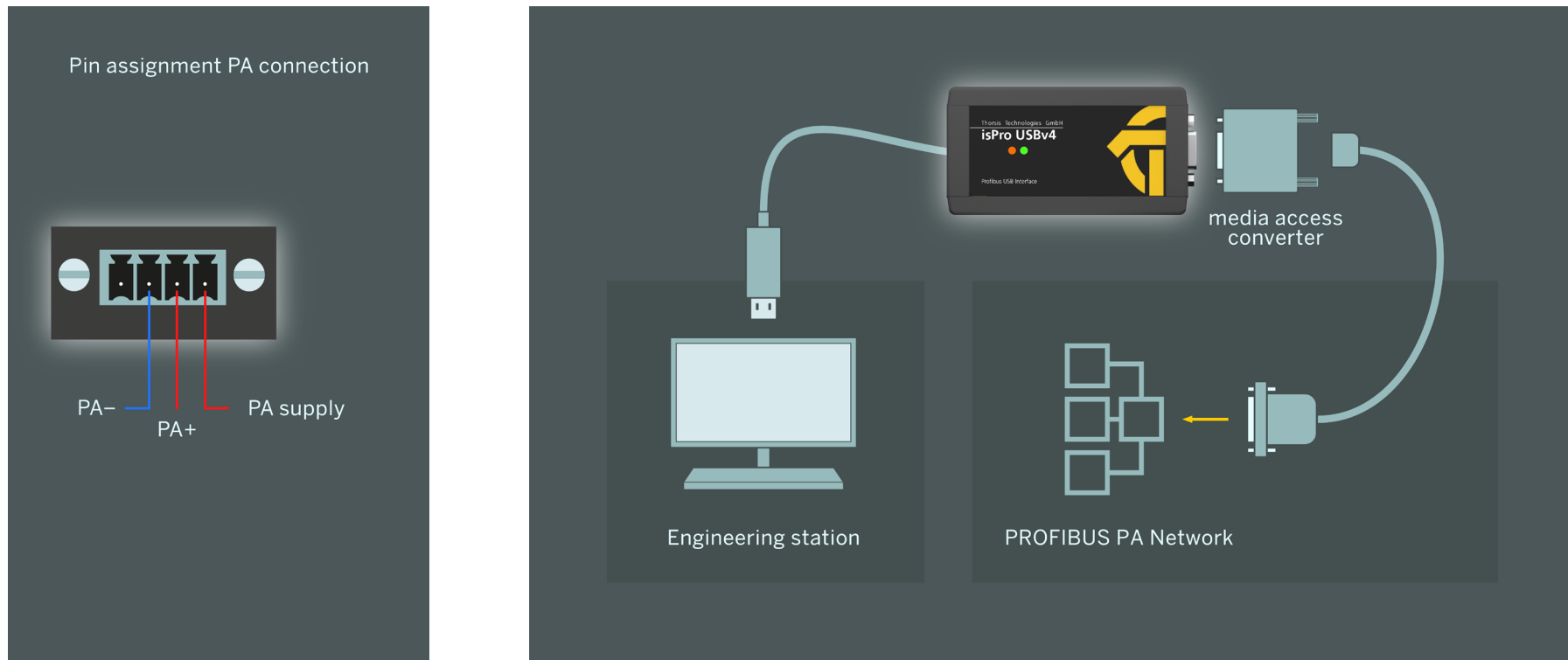

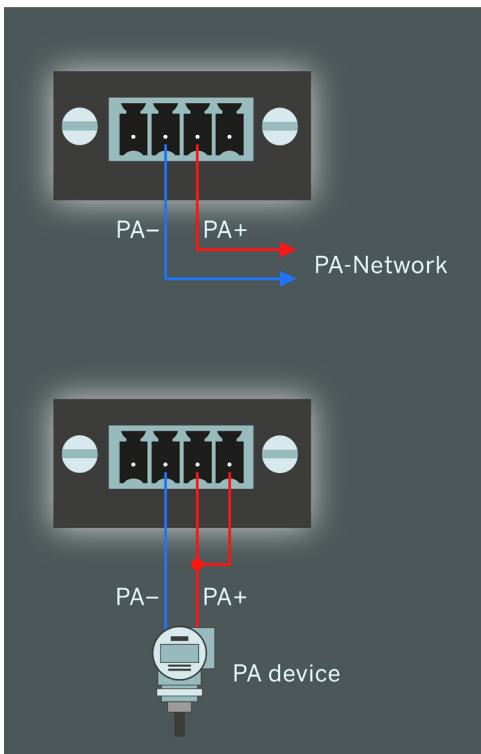

Connection to an existing PA bus

The adapter enables you to connect to an existing PA-Network via the signal lines PA+ and PA-.

Connection of a single field device

If you want to connect a single PROFIBUS PA Field device to the isPro USBv4 interface, the adapter for the bus offers another pin to supply the field device. For this purpose, the Signal line PA+ has to be connected to the voltage output.

3.3 Configuration and Commissioning

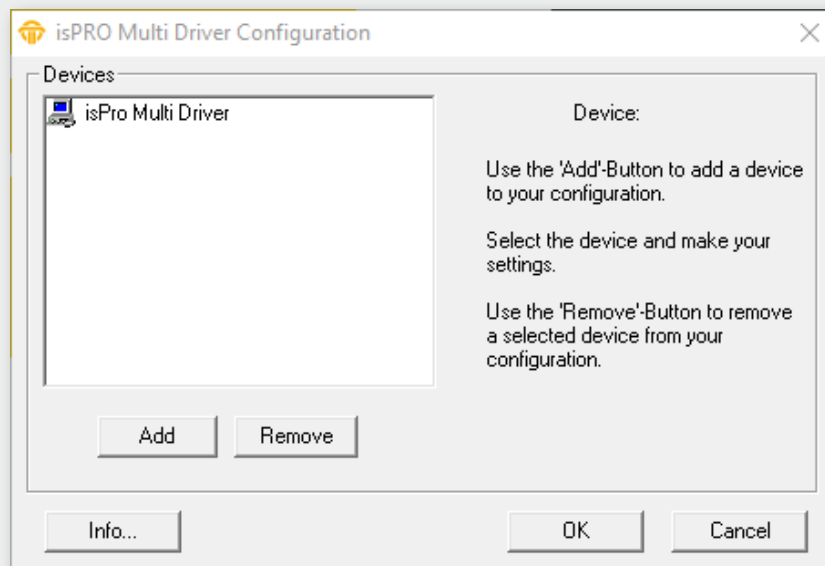

To ease the task of hardware configuration the configuration software isPro Configurator is provided. It is installed in the Start Menu. This simple dialog based program allows the easy addition and removal of the isPro interfaces. It also checks the available resources of the system.

Each device is assigned to a certain number which enables the software to address the device. Empty devices can be included in order to allow gaps in the enumeration of devices.

While the configuration software is running the device drivers of the hardware are stopped. All applications requiring access to the devices should be terminated before the start of the configuration software.

After the termination of the configuration software the device drivers are started again. The new parameters are available at once for all PCI and USB interfaces.

3.3.1 Add a device

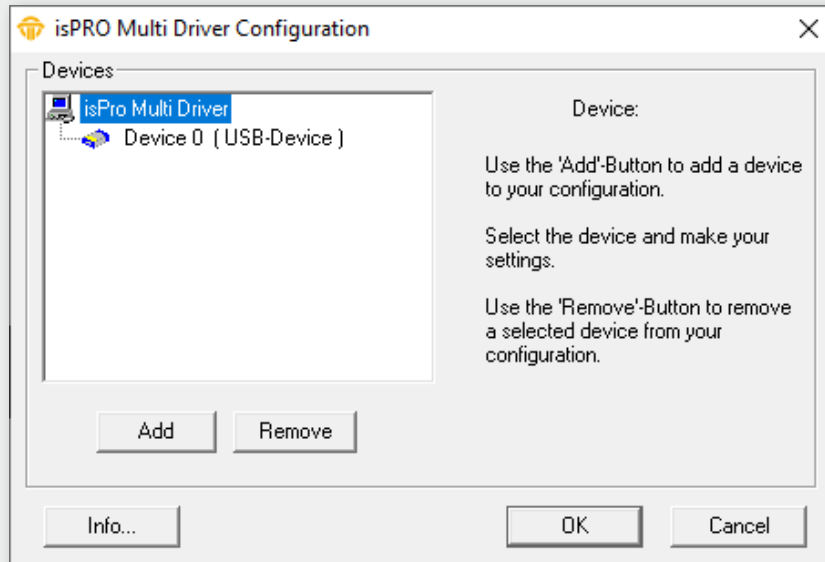

Please press the button "Add", choose the device type you would like to add. Press OK, then make your settings.

The USB interface possesses a serial number for clear identification. The number is located on the bottom of the case and stored internally. The configuration software offers the possibility to search automatically for all attached devices and to detect their serial numbers.

Finish your settings by clicking OK.

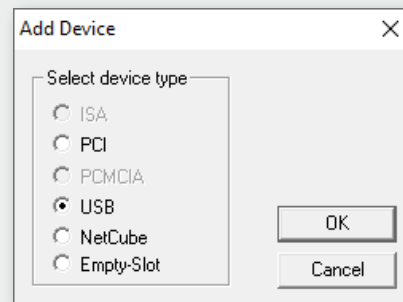

When adding a PCI board the configuration software searches for available resources and assigns them automatically to the new device. Marking the device allows the manual change of any parameter.

3.3.2 Add an Empty Slot

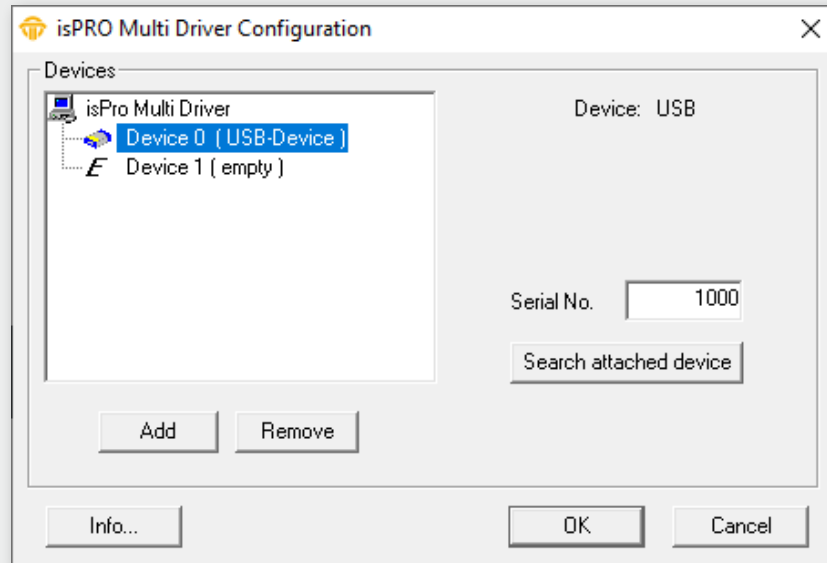

The empty device does not contain any resources. It serves as a substitute for device numbers not assigned. Using this devices enables a free enumeration of devices by inserting empty devices between the real ones.

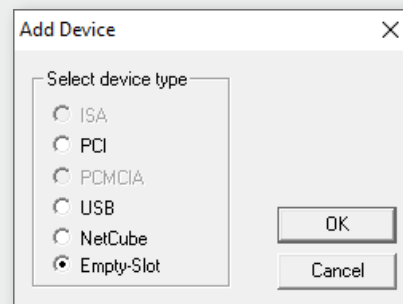

3.3.3 Removal of a device

Mark the device you wish to remove and press the button "Remove".
You can then remove the device from the USB port.

3.4 isPro Init Test

The driver software contains the program isPro Init Test to check the correct operation and installation of the driver software of the isPro interface.

The device and its hardware parameter, respectively its serial-number, has to be added to the configuration program isPro Configurator (see chapter „3.3 Configuration and Commissioning“ on page 14) before starting the program.
The program isPro Init Test initializes the PROFIBUS interface. It shows possible occurred error codes .

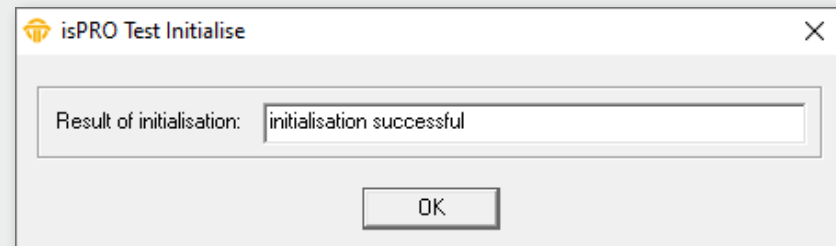

Note: The program isPro Init Test always initializes Device 0, means the first to the configuration program added device.

3.5 isPlover

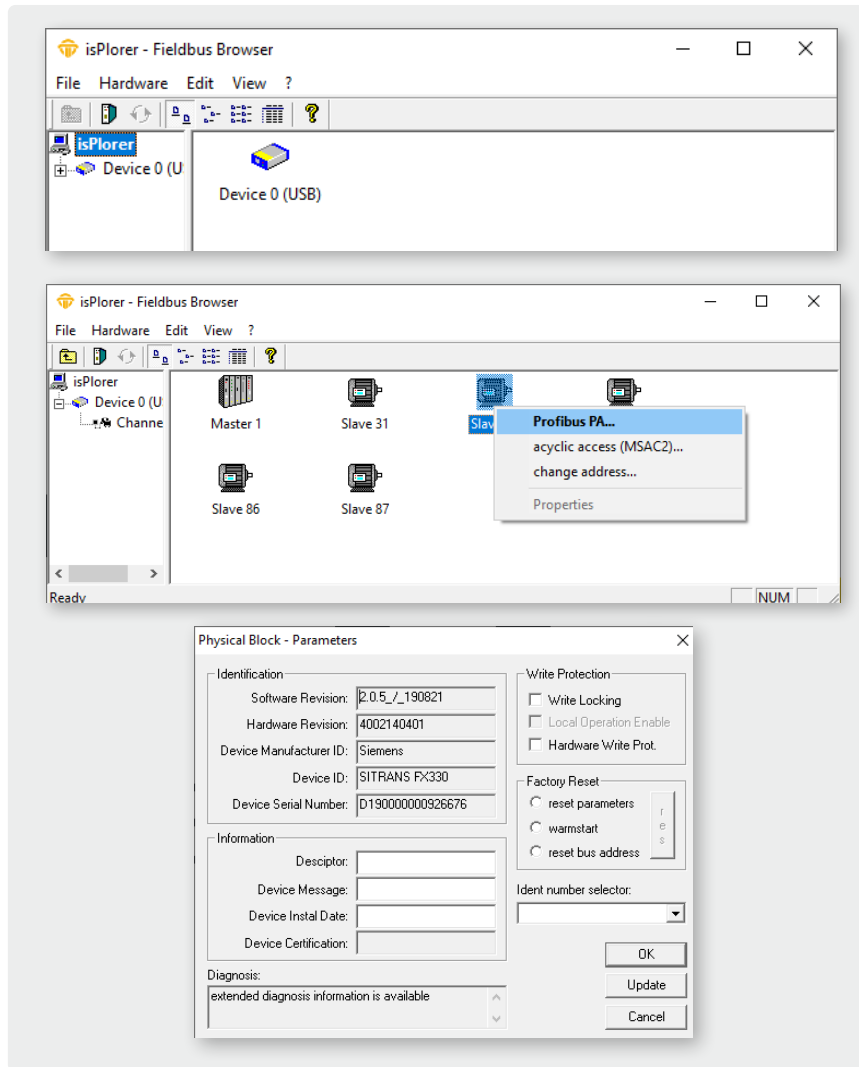

The included demo program isPlover enables the client to take first measures with the software. The program checks the operation of the PROFIBUS interface and the correct installation of the driver software.

Before starting the program, the device has to be added to the configuration program isPro Configurator (see chapter „3.3 Configuration and Commissioning“ on page 14). After starting the isPlover the device appears left in a tree view together with its PROFIBUS interfaces.

By choosing initialize... in the context menu, the device will be initialized. After initializing the program isPlover searches for PROFIBUS slaves which appear in the right window. The detail view shows further information e.g. the PNO-ID of connected slaves. Here, the station address of a slave can be changed, as far as the slave supports the changing of the address.

If the connected slave is a PROFIBUS PA-Slave conforming to PROFIBUS PA-Profile 3.0, a double click on the slave or with the context menu, the PA-slave blocks can be displayed.

The parameter of the physical block can be edited in the dialogue field.

4. Document History

Version	Date	Description
1.0	02.28.2020	initial version
1.1	02.09.2022	content update
1.2	04.17.2023	added UK Conformity Assessed marking

© last change on 6. November 2024